

**FIRE DEPARTMENT • CITY OF NEW YORK**



**STUDY MATERIAL FOR THE EXAMINATION FOR  
THE CERTIFICATE OF FITNESS FOR**

**CONSTRUCTION SITE FIRE SAFETY MANAGER**

**S-56**

FDNY is posting this study material for public to use as **“a reference guide”**

All applicants are required to attend the class and bring a certificate of completion from FDNY approved school to take FDNY S-56 Certificate of Fitness written exam”

## Table of Contents

<b>Exam Specific Information for S-56 Certificate of Fitness.....</b>	<b>6</b>
<b>STUDY MATERIAL AND TEST DESCRIPTON .....</b>	<b>10</b>
<b>DEFINITION .....</b>	<b>12</b>
<b>INTRODUCTION.....</b>	<b>22</b>
<b>CHAPTER 1. ROLE AND RESPONSIBILITIES .....</b>	<b>32</b>
<b>1.1 Designation of Construction Site Fire Safety Manager.....</b>	<b>32</b>
<b>1.2 The duties of Construction Site Fire Safety Manager (CSFSM) .....</b>	<b>32</b>
<b>CHAPTER 2. PREPARATION.....</b>	<b>34</b>
<b>2.1 Pre-Fire Plan for Construction Site .....</b>	<b>34</b>
<b>2.2 NFPA 241 Construction Fire Safety Program (best practice).....</b>	<b>37</b>
<b>2.3 Training.....</b>	<b>38</b>
<b>CHAPTER 3. FDNY PERMIT, CERTIFICATE OF FITNESS.....</b>	<b>39</b>
<b>3.1 Construction Site Relevant Certification of Fitness List .....</b>	<b>39</b>
<b>3.2 FDNY permits .....</b>	<b>40</b>
3.2.1 Three types of FDNY permits.....	40
3.2.2 Common FDNY Permits and related C of Fs at Construction Sites .....	43
<b>CHAPTER 4. FIRE PROTECTION SYSTEMS.....</b>	<b>46</b>
<b>4.1 Water Supplies.....</b>	<b>46</b>
<b>4.2 Standpipe System.....</b>	<b>47</b>
4.2.1 Standpipe System in Readiness.....	47
4.2.2 Fire Department Connections.....	48
4.2.3 Main Control Valve .....	50
4.2.4 Markings and Color Coding .....	52
4.2.5 Air Pressurized Alarm System for Dry Standpipe Systems.....	53
4.2.6 Standpipe System Inspections, Maintenance and Testing.....	58
<b>4.3 Sprinkler System .....</b>	<b>60</b>
<b>4.4 Out-of-service fire protection systems .....</b>	<b>62</b>
4.4.1 Fire watch.....	63
4.4.2 Fire guard.....	64
4.4.3 Planned Removal from Service.....	65
4.4.4 Unplanned out-of-service condition. ....	66
4.4.5 Required tag or signs.....	67
4.4.6 Notification to the Fire Department.....	68
4.4.7 Restoring systems to service. ....	69
4.4.8 Out-of-service standpipe systems at construction sites. ....	69
<b>CHAPTER 5. PORTABLE FIRE EXTINGUISHERS .....</b>	<b>71</b>
<b>5.1 Location and Size .....</b>	<b>71</b>
<b>5.2 Installation.....</b>	<b>73</b>
<b>5.3 Portable Fire Extinguishers Operation .....</b>	<b>74</b>
<b>5.4 Different Types of Portable Fire Extinguishers.....</b>	<b>75</b>
<b>5.5 Portable fire extinguisher tags, inspection and servicing.....</b>	<b>77</b>

5.5.1	Portable fire extinguisher (PFE) tags .....	77
5.5.2	Monthly Inspections.....	79
5.5.3	Portable fire extinguisher annual servicing .....	80
<b>CHAPTER 6. PRECAUTIONS AGAINST FIRE .....</b>		<b>81</b>
<b>6.1</b>	<b>Smoking Prohibited.....</b>	<b>81</b>
6.1.1	No Smoking Signs .....	81
<b>6.2</b>	<b>Open Fire, Waste Disposal and Housekeeping .....</b>	<b>82</b>
<b>6.3</b>	<b>Contractors sheds and offices (aka. Shanties) .....</b>	<b>84</b>
<b>6.4</b>	<b>Means of Egress and Elevators.....</b>	<b>85</b>
<b>6.5</b>	<b>Electrical .....</b>	<b>86</b>
<b>6.6</b>	<b>Fire-Resistance-Rated Construction .....</b>	<b>86</b>
<b>6.7</b>	<b>Watchperson While Construction Operation is not In Progress .....</b>	<b>86</b>
<b>6.8</b>	<b>Fire Watch and Fire Guard.....</b>	<b>88</b>
<b>6.9</b>	<b>S-60, F-01 and F-60 Comparison.....</b>	<b>88</b>
<b>CHAPTER 7. HOT WORK OPERATIONS .....</b>		<b>89</b>
<b>7.1</b>	<b>Permit and Certificate of Fitness .....</b>	<b>89</b>
7.1.1	Certificate of Fitness .....	89
7.1.2	Permit .....	89
7.1.3	Hot work program responsible person .....	90
<b>7.2</b>	<b>Operational requirements .....</b>	<b>90</b>
7.2.1	Authorized work areas .....	90
7.2.2	Hot work program authorization (not the FDNY permit).....	90
7.2.3	Pre-hot work check.....	92
7.2.4	Fire watch.....	94
7.2.5	Discontinued torch operations .....	96
<b>7.3</b>	<b>SAFEGUARDING ROOFING OPERATIONS .....</b>	<b>96</b>
7.3.1	Fire Extinguisher Requirements.....	98
7.3.2	Prohibited operations .....	98
<b>7.4</b>	<b>Recordkeeping.....</b>	<b>98</b>
<b>CHAPTER 8. FLAMMABLE GASES AND OXYGEN.....</b>		<b>100</b>
<b>8.1</b>	<b>Permit and Certificate of Fitness .....</b>	<b>100</b>
<b>8.2</b>	<b>General Requirements of Compressed and Liquefied Gases .....</b>	<b>100</b>
8.2.1	<i>General Requirement.....</i>	100
(1)	Labeling all compressed gas container clearly .....	101
(2)	Refilling container .....	101
(3)	Required signs .....	101
(4)	Empty containers .....	102
8.2.2	<i>Storing Containers .....</i>	102
(1)	Upright position .....	102
(2)	Gas cabinets .....	102
(3)	Incompatible materials.....	103
(4)	Separation from hazardous conditions .....	104

(5) Wiring and equipment .....	104
8.2.3 Containers in Use.....	105
8.2.4 Typical Internal Volume of Cylinders.....	105
8.2.5 Compressed Gas Container Disposal or Return .....	106
<b>8.3 LPG/CNG storage at construction sites .....</b>	<b>107</b>
<b>8.4 Portable liquid oxygen containers and oxygen trailer .....</b>	<b>110</b>
<b>8.5 Oxygen and acetylene gases used for torch operation .....</b>	<b>110</b>
8.5.1 Containers connected for use. ....	110
8.5.2 Storage requirements .....	111
8.5.3 Reserve oxygen and acetylene containers. ....	111
<b>CHAPTER 9. FLAMMABLE AND COMBUSTIBLE LIQUIDS .....</b>	<b>114</b>
<b>9.1 Class Flammable and Combustible Liquids.....</b>	<b>114</b>
<b>9.2 FDNY Permit and Certificate of Fitness.....</b>	<b>114</b>
<b>9.3 Housekeeping.....</b>	<b>115</b>
<b>9.4 Storage.....</b>	<b>116</b>
9.4.1 Quantity limits for containers storage.....	117
9.4.2 Liquid storage cabinets .....	117
9.4.3 Empty containers .....	118
9.4.4 Protections and clearance from combustibles .....	118
9.4.5 Tank Storage.....	118
<b>9.5 LABELING AND SIGNS .....</b>	<b>118</b>
9.5.1 NFPA Diamond Sign.....	118
9.5.2 Warning Signs and Labels .....	119
<b>CHAPTER 10. PORTABLE FUELED SPACE HEATERS.....</b>	<b>121</b>
<b>10.1 FDNY Permit and Certificate of Fitness requirements .....</b>	<b>121</b>
<b>10.2 Installation and Protection .....</b>	<b>121</b>
10.2.1 Escape hatches.....	122
<b>10.3 Portable Oil-Fueled Heater.....</b>	<b>123</b>
<b>10.4 Portable Gas-Fueled Heater.....</b>	<b>123</b>
10.4.1 Portable space heaters fueled by piped natural gas .....	123
10.4.2 Portable space heaters fueled by LPG.....	125
<b>10.5 Coke-fueled Salamanders.....</b>	<b>126</b>
10.5.1 Prohibited operations .....	126
10.5.2 Operation and Inspection Requirements.....	127
10.5.3 Portable Fire Extinguishers.....	128
10.5.4 Recordkeeping.....	128
<b>CHAPTER 11. INTERNAL-COMBUSTION-POWERED EQUIPMENT .....</b>	<b>129</b>
<b>CHAPTER 12. POWDER-ACTUATED TOOL LOADS .....</b>	<b>130</b>
<b>12.1 Related Permit and Certificate of Fitness requirements .....</b>	<b>130</b>
<b>12.2 Stored, Handled and Used for Powder-Actuated Tool Loads .....</b>	<b>130</b>
<b>CHAPTER 13. ASBESTOS PROJECTS .....</b>	<b>132</b>
<b>CHAPTER 14. AEROSOLS .....</b>	<b>135</b>

14.1	Levels of Aerosol Products .....	135
14.2	FDNY Permit and Certificate of Fitness requirements .....	136
14.3	Outdoor storage requirements .....	138
<b>CHAPTER 15. CRANE AERIAL FUELING OPERATIONS.....</b>		<b>139</b>
15.1	FDNY Permit and Certificate of Fitness requirements .....	139
15.2	Temporary Portable Tank .....	140
15.3	Portable Fire Extinguisher .....	140
<b>CHAPTER 16. Recordkeeping and CHECKLIST .....</b>		<b>141</b>
16.1	Construction Site Fire Safety Manager Daily Report .....	142
16.2	Watchperson Daily Record .....	145
16.3	Standpipe Weekly Inspection and Hydrostatic Test Record.....	146
16.4	Fire Watch for Impairment Record .....	147
16.5	Hot-work Record.....	149
16.6	Weekly Subcontractor Shanty Inspection Form.....	152
16.7	Project CSFSM Initiatives-Monthly Self-Assessment Form.....	154
16.8	CDA Walkthroughs .....	156
16.9	CDA Checklist .....	157
<b>CHAPTER 17. FIRE AND EMERGENCY PROCEDURES .....</b>		<b>158</b>
17.1	First Responder Box.....	158
17.2	Local Fire House Site Visits.....	161
17.3	Access for Firefighting .....	161
17.4	Notification Contact Numbers .....	161
17.5	Automatic air pressurized alarm activation.....	162
17.6	Emergency Notification .....	164
17.6.1	Emergency telephone .....	164
17.6.2	Emergency notification procedures.....	164
17.6.3	Prepare for the FDNY first responders and interaction .....	165
<b>Appendix A. FDNY District Office Contact Information .....</b>		<b>167</b>
<b>Appendix B. FIRE CODE .....</b>		<b>168</b>

## **Exam Specific Information for S-56 Certificate of Fitness**

### **An appointment is required to take the S-56 Certificate of Fitness Exam.**

Application and payment must be completed online prior to scheduling an appointment. **You must have** an FDNY COF application ID before scheduling the appointment.

Instructions for online application and payment can be found here:

<http://www1.nyc.gov/assets/fdny/downloads/pdf/business/fdny-business-cof-individuals-short.pdf>

Create an Account and Log in to:

<http://fires.fdnyccloud.org/CitizenAccess/SAML/NYCIDLogin.aspx>

To Schedule an appointment:

<http://www1.nyc.gov/site/fdny/business/all-certifications/cof-online-scheduler.page>

### **REQUIREMENTS FOR CERTIFICATE OF FITNESS APPLICATION**

#### **General requirements:**

Review the General Notice of Exam:

<http://www1.nyc.gov/assets/fdny/downloads/pdf/business/general-notice-of-exam-cof.pdf>

#### **Special requirements for S-56 Certificate of Fitness:**

Candidates **will not** be allowed to take the exam **without** the requirements listed below.

It is your responsibility to ensure you are qualified to take the S-56 exam before paying online and scheduling the appointment.

When you apply for the S-56 exam online, you **MUST UPLOAD** the copies of all following required materials listed below. The FDNY also recommends that you should bring the original document(s) with you when you take the exam.

**Conflicts of Interest Board (COIB).** The Conflicts of Interest Board (COIB) is an independent New York City agency tasked with interpreting and enforcing the conflicts of interest code for New York City's public workers. If you are an employee of a New York City Agency, you are responsible for seeking and obtaining written approval from the NYC Conflicts of Interest Board for permission.

- (1) Applicants shall upload one of the following Certifications or supporting documents that can verify the certification or experience required below:
  - a. A Site Safety Manager or Site Safety Coordinator Certificate issued by the Department of Buildings; or

- b.** At least three (3) years of full-time experience within the past six (6) years prior to the date of the application:
  - (i) working for a governmental agency or a construction, design or consulting firm;
  - (ii) at construction sites upon which “major buildings” (as that term is defined in BC3310.2) are being constructed; and
  - (iii) with responsibility for construction site safety and/or supervision of construction; or
- c.** At least eight (8) years of full-time experience within the past 12 years prior to the date of the application working for a governmental agency with responsibility for conducting and/or supervising fire code or fire safety inspections or enforcement; or
- d.** At least ten (10) years of full-time experience within the past 15 years prior to the date of the application working as a firefighter or fire officer in a paid fire department.

(2) The applicants provide the valid graduation certification issued to verify that they have completed a required training course. Applicants shall successfully complete a Construction Site Fire Safety Manager (CSFSM) course at a school certified by the FDNY. The FDNY certified school list:

<http://www1.nyc.gov/assets/fdny/downloads/pdf/business/approved-school-construction-fsm.pdf>

The **Graduation Certificate is valid for one year**. Applicants must pass the FDNY C of F test before it expires.

(3) Completed and signed S-56 application form.

<http://www1.nyc.gov/assets/fdny/downloads/pdf/business/cof-s56-application.pdf>

(4) Recommendation letter.

Sample of the recommendation letter is provided in the following page and available in the following link:

<http://www1.nyc.gov/assets/fdny/downloads/pdf/business/cof-s56-samplerec-letter.pdf>

**Application fee (cash is NO LONGER ACCEPTED):**

Pay the **\$25** application fee online or in person by one of the following methods:

- Credit card (*American Express, Discover, MasterCard, or Visa*)
- Debit card (*MasterCard or Visa*)
- In person: Personal or company check or money order (*made payable to the New York City Fire Department*)

A convenience fee of 2% will be applied to all credit card payments.

For fee waivers submit: **(Only government employees who will use their COF for their work- related responsibilities are eligible for fee waivers.)**

- A letter requesting fee waiver on the Agency’s official letterhead stating applicant full name, exam type and address of premises; **AND**
- Copy of identification card issued by the agency

## **EXAM INFORMATION**

The **S-56** exam will consist of **60** multiple-choice questions, administered on a “touch screen” computer monitor. It is a time-limit exam. Based on the amount of the questions, you will have 91 minutes to complete the test. A passing score of at least 70% is required in order to secure a Certificate of Fitness.

Please always check for the latest revised booklet at FDNY website before you take the exam.

<http://www1.nyc.gov/assets/fdny/downloads/pdf/business/cof-s56-noe-study-materials.pdf>

**Applicants will be given two (2) opportunities to take and pass the S-56 test.** After the second failure, applicants must repeat the CSFSM course and begin as a new applicant. The new graduation certification must be submitted or email to the Certificate of Fitness unit, Attn: Claudine McClintock ([mcclinc@fdny.nyc.gov](mailto:mcclinc@fdny.nyc.gov)) before making a new appointment for the written exam.

**Exam site:** **FDNY Headquarters, 9 MetroTech Center, Brooklyn, NY.** Enter through the **Flatbush Avenue entrance (between Myrtle Avenue and Tech Place).**

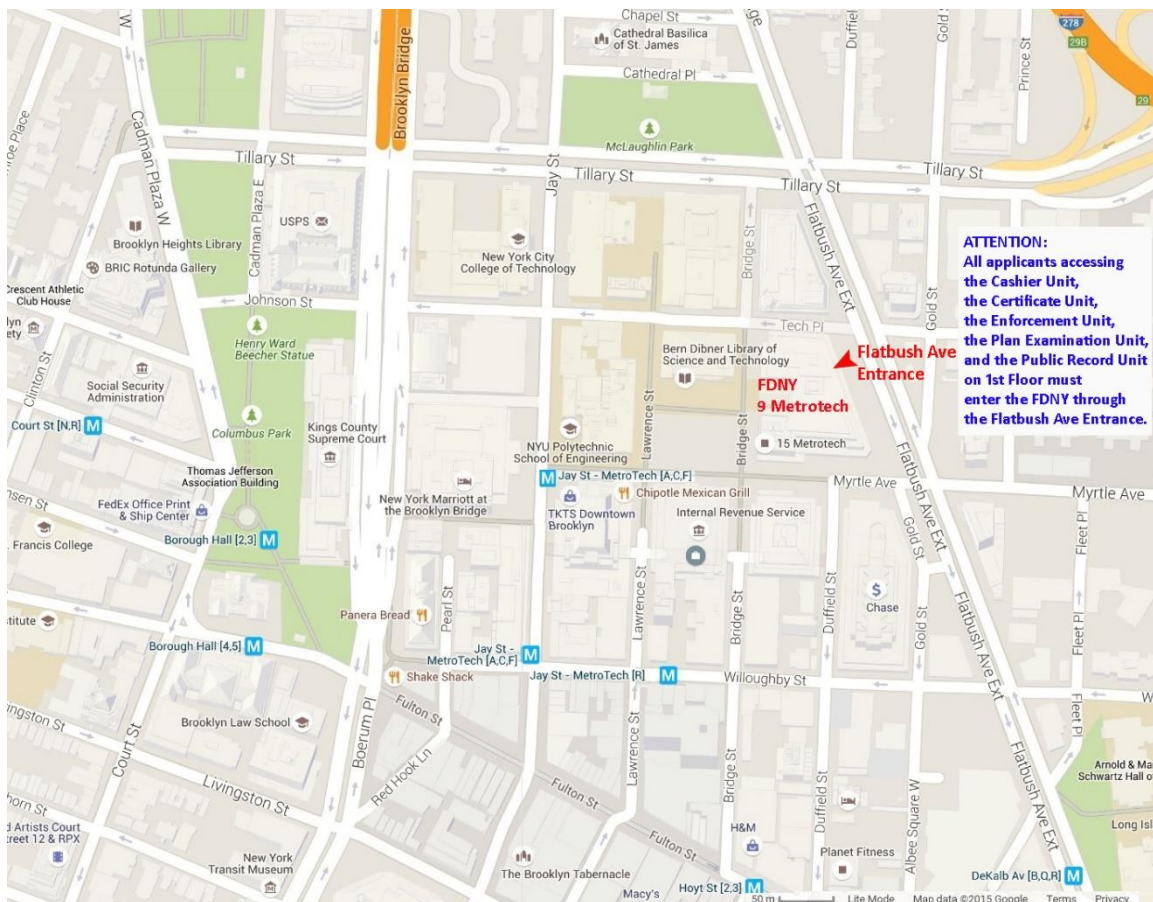



## **RENEWAL REQUIREMENTS**

### **General renewal requirements:**

You can review your COF online:

<http://www1.nyc.gov/assets/fdny/downloads/pdf/business/cof-simplified-renewal-short.pdf>

Review the General Notice of Exam:

<https://www1.nyc.gov/assets/fdny/downloads/pdf/business/general-notice-of-exam-cof.pdf>

**Special renewal requirements for S-56:** None.

## **QUESTIONS?**

**FDNY Business Support Team:** For questions, call 311 and ask for the FDNY Customer Service Center or send an email to [FDNY.BusinessSupport@fdny.nyc.gov](mailto:FDNY.BusinessSupport@fdny.nyc.gov)

## **STUDY MATERIAL AND TEST DESCRIPTON**

These study materials will help you prepare for the written examination for the Certificate of Fitness (C of F) for Construction Site Fire Safety Manager (S-56). It is your responsibility to become familiar with all applicable laws, rules and regulations of the federal, state and city agencies having jurisdiction, even though such requirements are not included in this study material. You need to be familiar with 2014 Fire Code Chapters 9, 26, 27, 30, 34, 35, 38 (please also refer to the corresponding 2022 Fire Code), Local Standpipe Laws, Local Law 58, 59, 63, and 64 which regulate CSFSM in order to adequately prepare for the exam. ***It is critical that you read AND understand this booklet to help increase your chance of passing this exam.***

### **2022 FIRE CODE ENACTED**

The amended New York City Fire Code, to be known as the 2022 Fire Code, takes effect on April 15, 2022. **It has NOT been updated in this study material and the exam will be mainly based on this booklet, not the 2022 Fire Code. However, as the Certificate of Fitness holder, it is your responsibility to become familiar with the applicable sections of the new 2022 Fire Code.**

### **Design and installation provisions.**

The design and installation provisions of the 2022 Fire Code shall apply to:

- Facilities established and conditions arising on or after 04/15/2022.
- Facilities and conditions not lawfully existing prior to 04/15/2022.

The facilities and conditions lawfully existing prior to the 04/15/2022 can be continued in compliance with the requirements of the former Fire Code/Fire Rule except as otherwise provided in the New Fire Code 102.5.

### **Operational and maintenance provisions.**

The operational and maintenance provisions of the 2022 Fire Code, including permit and certification requirements, shall apply to all facilities, operations, conditions, uses and occupancies, regardless of when they were established or arose.

Whenever this code is amended or a rule is promulgated to require a permit or certificate for a facility, operation, condition, use or occupancy, and no permit or certificate was previously required therefor pursuant to this code or the rules, such facility, operation, condition, use or occupancy may be continued without such permit or certificate until 04/15/2023, except as may otherwise be provided by such amendment or rule.

The 2022 Fire Code can be obtained via the following website:

<http://www1.nyc.gov/site/fdny/codes/fire-code/fire-code.page>

The 2014/2022 New York City Fire Code Cross-Reference Table can be referred to the following website:

<http://www1.nyc.gov/assets/fdny/downloads/pdf/codes/fire-code-cross-reference.pdf>

### **ABOUT THE TEST**

You must pass a multiple-choice test to qualify for the C of F. A score of 70% correct is required in order to pass the test. All questions have four answer options. Only one answer is correct for each question. If you do not answer a question, or if you mark more than one answer to a single question, your answer to that question will be scored as incorrect. Read each question carefully before marking your answer. There is no penalty for guessing.

### **SAMPLE QUESTIONS**

**1. Which of the following are allowed to be used while taking a Certificate of Fitness examination at 9 Metro Tech Center?**

- I. cellular phone
- II. study material booklet
- III. reference material provided by the FDNY
- IV. mp3 player

- A. III only
- B. I, II, and III
- C. II and IV
- D. I only

Only reference material provided by the FDNY is allowed to be used during Certificate of Fitness examinations. Therefore, the correct answer would be A. You would touch "A" on the computer terminal screen.

**2. If the screen on your computer terminal freezes during your examination, who should you ask for help?**

- A. the person next to you
- B. the firefighters in the testing room
- C. the examiner in the testing room
- D. the computer help desk

If you have a computer related question, you should ask the examiner in the testing room. Therefore, the correct answer would be C. You would touch "C" on the computer terminal screen.

**3. If you do not know the answer to a question while taking an examination, who should you ask for help?**

- A. the person next to you
- B. the firefighters in the testing room
- C. the examiner in the testing room
- D. you should not ask about test questions since FDNY staff cannot assist applicants

You should not ask about examination questions or answers since FDNY staff cannot assist applicants with their tests. Therefore, the correct answer would be D. You would touch "D" on the computer terminal screen.

## **DEFINITION**

**AEROSOL.** A product that is dispensed from a container by a propellant, classified as follows:

**Level 1.** Aerosol products with a total chemical heat of combustion that is greater than 0 and less than or equal to 8,600 British thermal units per pound (Btu/lb) (20 kJ/g).

**Level 2.** Aerosol products with a total chemical heat of combustion that is greater than 8,600 Btu/lb (20 kJ/g), but less than or equal to 13,000 Btu/lb (30 kJ/g).

**Level 3.** Aerosol products with a total chemical heat of combustion that is greater than 13,000 Btu/lb (30 kJ/g).

**AEROSOL CONTAINER.** A metal can, or a glass or plastic bottle designed to dispense an aerosol.

**ALTERATION.** Any addition to, or modification of, an existing installation or facility, other than any repair made in the ordinary course of maintenance.

**APPROVED.** Acceptable to the FDNY commissioner.

**ASPHALT MELTER.** An approved device designed to heat asphalt, typically for waterproofing operations, that, utilizing a flammable gas or a combustible liquid, generates an enclosed flame that indirectly heats a vessel containing the asphalt.

**AUTOMATIC.** As applied to fire protection devices, any device, equipment or system that initiates system function as a result of a predetermined temperature rise, rate of temperature rise, or combustion products, without the necessity for human intervention.

**BOILING POINT.** The temperature at which the vapor pressure of a liquid equals the atmospheric pressure of 14.7 pounds per square inch (psia) (101 kPa) or 760 mm of mercury. Where a boiling point is unavailable for the material in question, or for mixtures which do not have a constant boiling point, for the purposes of this classification, the 20-percent evaporated point of a distillation performed in accordance with ASTM D 86 shall be used as the boiling point of the liquid.

**BUILDING.** An enclosed structure designed or occupied to house any use or occupancy.

**BUILDING CODE.** The 2008 New York City Building Code in effect on and after July 1, 2008, and as amended thereafter.

**BUILDING OCCUPANTS.** All persons in the building, including employees, building staff and visitors.

**CENTRAL STATION.** A facility that receives alarm signals from a protected premises and retransmits or otherwise reports such alarm signals to the department.

**CERTIFICATE OF APPROVAL.** A written statement issued by the commissioner, certifying that an article, device or equipment, or type, class or kind thereof, has been examined, tested and approved for a specific purpose or use in conformity with the requirements of the construction codes, this code or the rules.

**CERTIFICATE OF FITNESS.** A written statement issued by the commissioner certifying that the person to whom it is issued has passed an examination as to his or her qualifications or is otherwise deemed qualified to perform one or more of the following duties, for which such certificate is required by this code or the rules: supervise a facility; conduct or supervise an operation; supervise the storage,

handling and/or use of a material; or conduct or supervise emergency planning and preparedness activities.

**CITYWIDE STANDARD KEY.** A key of special or controlled design, also known as a “2642” key, approved by the commissioner which serves to operate elevator emergency recall and emergency in-service operation service switches and other devices or locks as required by the construction codes, including the Building Code, this code or the rules.

**CLOSED CONTAINER.** A container sealed by means of a lid or other device capable of preventing the escape of liquid, vapor or dusts in the ordinary course of storage, handling or use.

**CNG.** Compressed natural gas.

**COKE.** A solid carbonaceous material manufactured from the distillation of bituminous coal, petroleum or coal tar, with a thermal heating value of not more than 13,200 British thermal units per hour (3869 W), a volatile composition of not more than 0.5 percent, an NFPA Standard 704 fire hazard rating of not more than 1, and an NFPA Standard 704 reactivity rating of 0.

**COKE-FUELED SALAMANDER.** A metal vessel, typically cylindrical in shape, used to burn coke in the open air for the purpose of maintaining an open fire for construction-related curing and drying. A coke-fueled salamander does not utilize a combustible liquid or flammable gas and does not generate a flame in a sustained or controlled manner and therefore is not an open flame device or portable space heater as those terms are used in this code.

**COMBUSTIBLE LIQUID.** For purposes of transportation, a combustible liquid, as defined in the regulations of the United States Department of Transportation, as set forth in 49 CFR Section 173.120. For all other purposes, a liquid, other than a compressed gas or cryogenic fluid, having a closed cup flash point at or above 100°F (38°C), classified as follows:

**Class II.** Liquids having a closed cup flash point at or above 100°F (38°C) and below 140°F (60°C).

**Class IIIA.** Liquids having a closed cup flash point at or above 140°F (60°C) and below 200°F (93°C).

**Class IIIB.** Liquids having closed cup flash points at or above 200°F (93°C).

**COMBUSTIBLE WASTE.** Any substance, item or other organic or inorganic matter that presents a fire hazard and is a byproduct or residue of the construction, use or occupancy of any premises, or any activity conducted thereon, that has no economic value in connection with such use or occupancy. A combustible waste that has economic value in connection with the use and occupancy of such premises shall be deemed to be a combustible material.

**COMPRESSED GAS.** A material, or mixture of materials, that is a gas at 68oF (20oC) or less at 14.7 psia (101 kPa) of pressure; and has a boiling point of 68oF (20oC) or less at 14.7 psia (101 kPa) that is either liquefied, nonliquefied or in solution at that temperature and pressure, except that gases which have no other health- or physical-hazard properties are not considered to be compressed until the pressure in the packaging exceeds 41 psia (28 kPa) at 68oF (20oC). Compressed gases shall be classified as follows:

**NONLIQUEFIED COMPRESSED GASES.** Gases, other than those in solution, that are in a packaging under the charged pressure and are entirely gaseous at a temperature of 68°F (20°C).

**Liquefied compressed gases.** Gases that, in a packaging under the charged pressure, are partially liquid at a temperature of 68°F (20°C).

**Compressed gases in solution.** Nonliquefied gases that are dissolved in a solvent.

**Compressed gas mixtures.** A mixture of two or more compressed gases contained in a single packaging, the hazard properties of which are represented by the properties of the mixture as a whole.

**COMPRESSED GAS CONTAINER.** A pressure container designed to hold compressed gases at pressures greater than one atmosphere at 68°F (20°C).

**CONSTRUCTION CODES.** The 2008 New York City construction codes, consisting of the New York City Building, Fuel Gas, Mechanical and Plumbing Codes in effect on and after July 1, 2008, and as amended thereafter.

**CONSTRUCTION SITE.** Any location at which a building, structure, premises or facility is undergoing construction, alteration or demolition.

**CONTAINER.** For solid and liquid hazardous materials, a vessel of 60 gallons (227 L) or less in capacity used for storage or transportation. For compressed gases, a cylinder, pressure vessel or tank designed for pressures greater than one atmosphere at 68°F (20°C). Pipes, piping systems, engines and engine fuel tanks associated with solid or liquid hazardous materials or compressed gases, shall not be deemed to be containers if in active use.

**DESIGN AND INSTALLATION DOCUMENTS.** Plans and specifications, or other written, graphic and pictorial documents or submissions, setting forth the location, design, arrangement and physical characteristics of the device, equipment, system, operation or facility for which approval by the commissioner is sought.

**DISPENSING.** The pouring or transferring by other means of any material from a container, tank or similar vessel, which would release dusts, fumes, mists, vapors or gases to the atmosphere, unless such release is prevented by a device, equipment or system designed for that purpose.

**ELECTRICAL CODE.** The 2007 New York City Electrical Code in effect on July 1, 2008, and as amended thereafter.

**EMERGENCY SHUTOFF VALVE.** A valve designed to shut off the flow of gases or liquids.

**EMERGENCY SHUTOFF VALVE, AUTOMATIC.** A fail-safe self-closing valve designed to shut off the flow of liquids or gases upon activation of the valve's control system by automatic means.

**EMERGENCY SHUTOFF VALVE, MANUAL.** A manually operated valve designed to shut off the flow of liquids or gases.

**EVACUATION.** The emptying of a building or part thereof of building occupants in response to a fire or non-fire emergency.

**EXHAUSTED ENCLOSURE.** A device, typically consisting of a hood equipped with a fan that serves to capture and exhaust fumes, mist, vapors and gases generated at a workstation or other local environment. An exhausted enclosure does not include a room provided with general ventilation.

**EXIT.** That portion of a means of egress system which is separated from other interior spaces of a building or structure by fire-resistance-rated construction and opening protectives as required to provide a protected path of egress travel between the exit access and the exit discharge. Exits include vertical exits, exterior exit doors at the level of exit discharge, vertical exit enclosures, exit passageways, exterior exit stairs, exterior exit ramps and horizontal exits, but do not include access stairways, aisles, exit access doors opening to corridors or corridors. This term shall include the locations on a premises at which egress may be had from an enclosed outdoor space.

**EXIT ACCESS.** That portion of a means of egress system that leads from any occupied portion of a building, structure or premises to an exit.

**FAIL-SAFE.** A feature of the design of a device, equipment or system that automatically counteracts the effect of an anticipated possible source of failure, or prevents or mitigates a hazardous condition by automatically compensating for a failure or malfunction of the device, equipment or system.

**FIRE.** A rapid, persistent chemical reaction that releases heat and light, especially the burning of a combustible substance in the presence of oxygen. For purposes of this code, a flame used in any lawful, properly operating device, equipment or system or other controlled setting shall not be considered a fire.

**FIRE ALARM BOX, MANUAL.** A manually operated device used to initiate an alarm signal.

**FIRE ALARM SIGNAL.** A signal initiated by a fire alarm-initiating device such as a manual fire alarm box, automatic fire detector, water-flow switch, or other device whose activation is indicative of the presence of a fire or fire signature.

**FIRE ALARM SYSTEM.** Any system, including any interconnected fire alarm subsystem, of components and circuits arranged to monitor and annunciate the status of fire alarm or supervisory signal-initiating devices.

**FIRE DETECTOR, AUTOMATIC.** A device designed to detect the presence of a fire signature and to initiate action.

**FIRE APPARATUS ACCESS ROAD.** A road that serves to provide access for fire apparatus from a public street to the frontage space of one or more buildings not directly fronting on a public street. A fire apparatus access road includes any road that serves such purpose whether denominated as a driveway, parking lot lane, private road or private street.

**FIRE AREA.** The aggregate floor area enclosed and bounded by fire walls, fire barriers, exterior walls and/or horizontal assemblies of a building. Areas of the building not provided with surrounding walls shall be included in the fire area if such areas are included within the horizontal projection of the roof or floor next above.

**FIRE COMMAND CENTER.** The principal attended or unattended location where the status of the detection, alarm communications and control systems is displayed, and from which the system(s) can be manually controlled.

**FIRE DEPARTMENT STANDARD KEY.** A key of special or controlled design, also known as a "1620" key, for the use of department personnel and others specifically authorized by the commissioner, which serves to operate all switches, locks and other devices required to be operable by a citywide standard key.

**FIRE DRILL.** A training exercise by which building occupants are familiarized with and/or practice the procedures for the safe, orderly and expeditious sheltering in place, in-building relocation, partial or full evacuation, or any combination thereof, in the event of a fire, in accordance with the emergency preparedness plan for the premises.

**FIRE GUARD.** A person holding a certificate of fitness for such purpose, who is trained in and responsible for maintaining a fire watch.

**FIRE PROTECTION SYSTEM.** Approved devices, equipment and systems or combinations of systems used to detect a fire, activate an alarm, extinguish or control a fire, control or manage smoke and products of a fire or any combination thereof, including fire extinguishing systems, fire alarm systems, sprinkler systems and standpipe systems.

**FIRE WATCH.** A temporary measure intended to ensure continuous and systematic surveillance of a building or portion thereof by one or more qualified individuals for the purposes of identifying and controlling fire hazards, including detecting early signs of fire, raising an alarm of fire, notifying the department, and performing such other fire safety duties as may be prescribed by the commissioner.

**FLAMMABLE AND COMBUSTIBLE LIQUID STORAGE SYSTEM.** A flammable or combustible liquid storage tank and all devices, equipment and systems associated with such tank, including the tank, piping, valves, fill connection, vent lines, pumps and any other ancillary equipment, except liquid motor fuel storage and dispensing systems and flammable and combustible liquid storage systems at a bulk plant or terminal used for bulk transfer operations.

**FLAMMABLE GAS.** A material which has a boiling point and becomes a gas at 68°F (20°C) or less at 14.7 pounds per square inch absolute (psia) (101 kPa) of pressure which:

1. Is ignitable at 14.7 psia (101 kPa) when in a mixture of 13 percent or less by volume with air, in accordance with testing procedures set forth in ASTM E 681; or
2. Has a flammable range at 14.7 psia (101 kPa) with air of at least 12 percent, regardless of the lower explosive limit, in accordance with testing procedures set forth in ASTM E 681.

**FLAMMABLE LIQUID.** For purposes of transportation, a flammable liquid defined in the regulations of the United States Department of Transportation, as set forth in 49 CFR Section 173.120. For all other purposes, a liquid, other than a compressed gas or cryogenic fluid, having a closed cup flash point below 100°F (38°C), classified as follows:

**Class IA.** Liquids having a flash point below 73°F (23°C) and having a boiling point below 100°F (38°C).

**Class IB.** Liquids having a flash point below 73°F (23°C) and having a boiling point at or above 100°F (38°C).

**Class IC.** Liquids having a flash point at or above 73°F (23°C) and below 100°F (38°C).

**FLAMMABLE LIQUID MOTOR FUEL.** Gasoline or other flammable liquids used as fuel in the operation of motor vehicles, motorcycles, watercraft and aircraft.

**FLAMMABLE MATERIAL.** A material capable of being readily ignited from common sources of heat or at a temperature of 600oF (316oC) or less.



**FLASH POINT.** The minimum temperature in degrees Fahrenheit at which a liquid will give off sufficient vapors to form an ignitable mixture with air near the surface or in the container, but will not sustain combustion. The flash point of a liquid shall be determined by appropriate test procedure and apparatus as specified in ASTM D 56, ASTM D 93 or ASTM D 3278.

**FLOOR FINISHING OPERATION.** Any activity involving the surfacing or finishing of a floor, including but not limited to cleaning, stripping, sealing, painting, varnishing, lacquering, staining and waxing.

**GAS CABINET.** A fully enclosed, noncombustible enclosure used to provide an isolated environment for compressed gas containers in storage or use, including any doors and access ports for exchanging containers and accessing pressure-regulating controls.

**GENERAL SUPERVISION.** Except as otherwise provided in this code, supervision by the holder of any department certificate who is responsible for performing the duties set forth in FC113.2 but need not be personally present on the premises at all times.

**HANDLING.** The movement of a material in its container, the removal of the material from its container, or any other action or process that may affect the material, other than its storage or use.

**HAZARDOUS MATERIALS.** Those chemicals or substances that are physical hazards or health hazards as defined and classified in this chapter, whether the materials are in usable or waste condition.

**HEALTH HAZARD.** A classification of a chemical for which there is statistically significant evidence that acute or chronic health effects are capable of occurring in exposed persons. The term "health hazard" includes chemicals that are toxic, highly toxic and corrosive.

**HOT WORK.** Cutting, welding, thermit welding, brazing, soldering, grinding, thermal spraying, thawing pipe, cadwelding, installation of torch-applied roof systems or any other similar operation or activity.

**HOT WORK AREA.** The area exposed to sparks, hot slag, radiant heat, or convective heat as a result of hot work.

**HOT WORK EQUIPMENT.** Electric or gas welding or cutting equipment used for hot work.

**HOT WORK PROGRAM.** A program, implemented by a responsible person designated by the owner of a building or structure in or on which hot work is being performed, to oversee and issue authorizations for such hot work for the purpose of preventing fire and fire spread.

**HOT WORK PROGRAM AUTHORIZATIONS.** Authorizations issued by the responsible person under a hot work program allowing welding or other hot work to be performed at the premises.

**IMPAIRMENT COORDINATOR.** The person responsible for ensuring that proper safety precautions are taken when a fire protection system is out of service.

**INITIATING DEVICE.** A system component that originates transmission of a change-of-state condition, such as in a smoke detector, manual fire alarm box, or supervisory switch.

**INCOMPATIBLE MATERIALS.** Materials that, if mixed or combined, could explode, generate heat, gases or other byproducts, or react in a way hazardous to life or property.

**INERT GAS.** Argon, helium, krypton, neon, nitrogen, xenon or other gas that does not react with other materials under atmospheric pressures and other conditions ordinarily encountered in common use.

**JOB SITE.** The construction site at which blasting operations are being conducted, including the blast site and blast area.

**KEY BOX.** A secure device with a lock operable only by a citywide standard key or other approved key.

**LARGE-AREA BUILDING.** A building that is not a high-rise building, but is either a Group B office building within the meaning of Section 907.2.2.2 of the Building Code that has a total gross area of more than 100,000 square feet or a building of an occupancy type other than Group R-2 or Group R-3 that has a total gross area of more than 100,000 square feet.

**LIQUID MOTOR FUEL.** Gasoline, diesel fuel or other flammable or combustible liquids used as fuel in the operation of motor vehicles, motorcycles, marine vessels and watercraft.

**LIQUEFIED PETROLEUM GAS (LPG).** A material which is composed predominantly of the following hydrocarbons or mixtures of them: propane, propylene, butane (normal butane or isobutane) and butylenes. Methylacetylene-propadiene mixtures (MAPP-gas) shall be deemed to be an LPG.

**LIQUID.** A material having a melting point that is equal to or less than 68°F (20°C) and a boiling point that is greater than 68°F (20°C) at 14.7 psia (101 kPa). When not otherwise identified, the term “liquid” includes both flammable and combustible liquids.

**LISTED.** A material, device, equipment or system included on a list published by a nationally recognized testing laboratory or other approved organization performing product evaluations that maintains periodic inspection of production of such listed material, device, equipment or system, and whose listing indicates compliance with nationally recognized standards and designates suitable usage.

**LOWER FLAMMABLE LIMIT (LFL).** The minimum concentration of vapor in air at which propagation of flame will occur in the presence of an ignition source. The LFL is sometimes referred to as LEL or lower explosive limit.

**MATERIAL SAFETY DATA SHEET (MSDS/SDS).** A document prepared in accordance with the regulations of the United States Department of Labor, as set forth in 29 CFR Part 1910.1200 or a federally approved state OSHA plan which sets forth information concerning a hazardous material.

**MEANS OF EGRESS.** A continuous and unobstructed path of vertical and horizontal egress travel from any occupied portion of a building, structure or premises to a public way. A means of egress consists of three separate and distinct parts: the exit access, the exit and the exit discharge.

**MECHANICAL CODE.** The 2008 New York City Mechanical Code in effect on July 1, 2008, and as amended thereafter.

**NATURAL GAS.** A mixture of hydrocarbon gases and vapors, consisting principally of methane in gaseous form.

**NON-FIRE EMERGENCY.** A biological, chemical or nuclear incident or release; declaration of emergency by a lawful authority; explosion; medical emergency; natural disaster; or other emergency affecting the premises or the safety of building occupants.

**NON-FIRE EMERGENCY DRILL.** A training exercise by which building occupants are familiarized with and/or practice the procedures for safe, orderly and expeditious sheltering in place, in-building relocation, partial or full evacuation, or combination thereof, in the event of a non-fire emergency, in accordance with the emergency preparedness plan for the premises.

**OPEN FIRES.** The burning of materials wherein products of combustion are emitted directly into the ambient air without passing through a stack or chimney from an enclosed chamber. For the purpose of this definition, a chamber shall be regarded as enclosed when, during the time combustion occurs, only apertures, ducts, stacks, flues or chimneys necessary to provide combustion air and permit the escape of exhaust gas are open.

**OPEN FLAME.** A flame that is generated by any material or device in a sustained and controlled manner and that is not securely enclosed by noncombustible material, such as a candle that is unenclosed or enclosed in a globe or lantern, or a gas light lantern, but not a flame contained in a furnace or other similar approved device, equipment or system. Torches operated in accordance with FC Chapter 26 and lighted smoking paraphernalia shall not be considered an open flame.

**OPEN-FLAME DEVICE.** Any device utilizing an open flame.

**OUTDOOR CONTROL AREA.** An outdoor area that contains hazardous materials in amounts not exceeding the maximum allowable quantities of Table 2703.1.1(3) or 2703.1.1(4).

**OUT-OF-SERVICE SYSTEM.** A fire protection system that is not fully functional; or whose operation is impaired or is otherwise not in good working order.

**OWNER.** The owner of the freehold of any real property (as defined in section two of the Real Property Law), or of a lesser estate therein, a mortgagee or vendee in possession, assignee of rents, receiver, executor, trustee, lessee, agent, or any other person, firm or corporation, directly or indirectly in control of real property. Any reference in this code to the owner of any building, structure or premises shall be deemed to designate collectively any and all of the foregoing, including, but not limited to, the owner of the freehold or lesser estate therein and a managing agent designated by such owner pursuant to Section 27-2098 of the New York City Administrative Code.

**OXIDIZING GAS.** A gas that can support and accelerate combustion of other materials more than air does.

**PERMIT.** A written statement issued by the commissioner authorizing the manufacture, storage, handling, use or transportation of a hazardous material, or other material, or to conduct an operation or to maintain a facility, for which a permit is required by this code.

**PERSONAL SUPERVISION.** Except as otherwise provided in this code, supervision by the holder of any department certificate who is required to be personally present on the premises, or other proximate location acceptable to the department, while performing the duties for which the certificate is required.

**PIPED NATURAL GAS.** Natural gas supplied by means of piping connected to a distribution system operated by a public utility.

**PLUMBER.** A licensed master plumber, as that term is defined by the Building Code, or a person working under the direct and continuing supervision of a licensed master plumber, as authorized by said code.

**PORTABLE SPACE HEATER.** Any portable equipment designed or used for space heating that utilizes a combustible liquid or flammable gas as a fuel, whether or not flue-connected.

**POWERED INDUSTRIAL EQUIPMENT.** Equipment used in commercial and industrial applications, including floor scrubbers and floor buffers, powered by a lead-acid battery system.

**POWERED INDUSTRIAL TRUCK.** A forklift, tractor, platform lift truck or motorized hand truck powered by a lead-acid battery system, a metal hydride hydrogen storage system or an internal combustion engine. Powered industrial trucks do not include farm vehicles or motor vehicles for highway use.

**PREMISES.** Any real property, including buildings and structures thereon, or any part thereof.

**PRIVATE ROAD.** A private driveway, lane or street, or other means of vehicular access to one or more buildings, structures or premises not directly fronting on a public street. A private road does not include a public street.

**PROCESS TRANSFER.** The transfer of flammable or combustible liquids between cargo tanks or tank cars and containers, tanks piping and other equipment that is to be used in process operations.

**PROTECTED PREMISES.** A building, occupancy or structure located in the city that is equipped with a fire alarm system that transmits an alarm signal to the department or a central station that monitors such system for the purposes of reporting fire alarms to the department, whether or not the installation of such system on the premises is required by law.

**PUBLIC STREET.** All streets, including mapped streets, record streets, marginal streets and restricted use streets, established on the city map maintained pursuant to Section 198 of the New York City Charter or dedicated for general public use and accepted for such purposes by the City of New York.

**RESPONSIBLE PERSON.** A person trained in the fire safety hazards associated with hot work and in the necessary and appropriate measures to minimize those hazards, who is designated by the owner of a premises to authorize the performance of hot work at the premises.

**RUBBISH.** Combustible and noncombustible waste materials, including dust, dirt, ashes, rags, paper, cartons, cans, plastic and glass containers, and discarded appliances.

**SAFETY CAN.** An approved container (e.g. approved metal safety cans must meet the requirement of ANSI/UL 30, Standard for Metal Safety Cans) with a capacity of not more than 5-gallons (19 L) and equipped with a spring-closing lid and spout cover designed to relieve internal pressure when exposed to fire.

**SMALL ARMS AMMUNITION.** A shotgun, rifle or pistol cartridge, and any cartridge for propellant-actuated devices, excluding ammunition containing bursting charges or incendiary, trace, spotting or pyrotechnic projectiles.

**SMALL ARMS AMMUNITION PRIMERS.** Small percussion-sensitive explosive charges, encased in a cap, used to ignite propellant powder.

**SMOKE DETECTOR.** A listed device that senses visible or invisible particles of combustion.

**SPRINKLER SYSTEM.** A fire extinguishing system, other than a mist fire extinguishing system, that utilizes water as the extinguishing agent.

**STANDARD CUBIC FEET (SCF).** Cubic feet of gas at normal temperature and pressure (NTP).

**STANDPIPE, MULTI-ZONE.** A standpipe system that is vertically subdivided as required by the construction codes, including the Building Code, into zones to limit the maximum operating pressure in the system. Each zone will have its own individual automatic water supply.

**STANDPIPE SYSTEM.** Piping installed in a building or structure that serves to transfer water from a water supply to hose connections at one or more locations in a building or structure used for firefighting purposes.

**STRUCTURE.** Any construction on, above or below real property, including buildings, enclosures, sheds and tents.

**SYSTEM.** An assembly of devices, equipment, containers, appurtenances, pumps, compressors and connecting piping that is designed to perform a complex and/or complete function.

**TANK.** A vessel containing more than 60 gallons (227 L).

**TANK, PORTABLE.** A container of more than 60-gallon (227 L) capacity, and designed to be loaded into or on or temporarily attached to a transport vehicle, marine vessel, or watercraft and equipped with skids, mountings or accessories to facilitate handling of the tank by mechanical means. It does not include any cargo tank or tank car.

**TANK, STATIONARY.** A container having not less than 1,000-pound (454 kg) water capacity, designed primarily for stationary installations, and not intended to be moved in the course of normal use.

**TAR KETTLE.** A device designed to heat tar, asphalt, pitch or similar materials, typically for waterproofing operations, that, utilizing a flammable gas or a combustible liquid, generates a flame to heat a vessel containing such a material. Tar kettle does not include asphalt melters.

**TORCH-APPLIED ROOF SYSTEM.** Bituminous roofing systems using membranes that are adhered by heating with a torch and melting asphalt back coating instead of mopping hot asphalt for adhesion.

## INTRODUCTION

The FDNY FC Section 1408 requires a Construction Site Fire Safety Manager (CSFSM) on New York City construction sites where a site safety manager or site safety coordinator is required by the Building Code to ensure compliance with the Fire and Building code requirements. This study material will help you prepare for the written examination for the C of F for CSFSM. This study material includes information taken from the New York City Fire Code (FC), New York City Fire Department Rules, New York City Building Code, and the industries' recommendations.

The booklet also contains recommendations that are called “**Best Practices**” in *italics*. Statements written in regular font are mandatory and/or informational. **Best Practices** are based on other regulatory requirements such as OSHA and industry practice. If adopted, the best practices should improve fire protection and are highly recommended by the FDNY and construction industry representatives. They are, however, not required at this time.

**Shall** – The use of the word “**shall**” throughout these study materials generally refers to a requirement of the Fire Code or the FDNY.

**Should** - The use of the word “**should**” throughout these study materials generally refers to policies, procedures and/or best practices recommended by the FDNY, and may not be a codified requirement.

### **Why are buildings under construction at such high risk?**

- Buildings under construction are largely unprotected—fire-protection systems such as sprinklers, smoke detection, fire alarms, and fire walls are typically nonexistent or not yet operational until a building is near completion. Construction site fires can spread rapidly before the fire department can arrive.
- Some construction sites are unsecured and are then vulnerable to trespassing, which can lead to vandalism, theft, and intentionally set fires.
- Ignition sources are common on construction sites, including equipment (such as heaters) and hot work (such as welding, cutting, grinding, soldering, and roofing of various kinds). Any lapse in adherence to safety procedures can result in damage to the site itself as well as to adjacent buildings and can put site workers, civilians, and first responders at risk of injury and death.

## Fire History Review

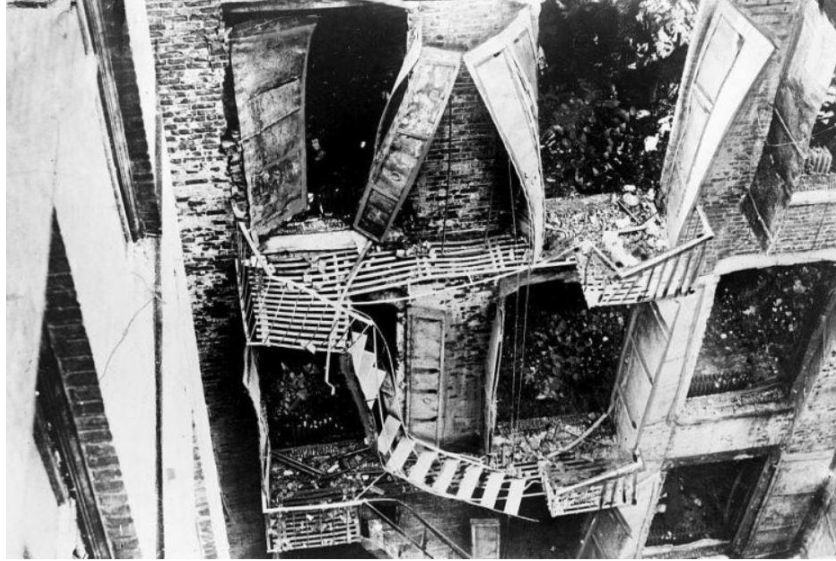

### **1. Triangle Shirtwaist Factory Fire, NYC (March, 1911)**

#### Fire Summary

A fire started because of a dropped cigarette. Confined factory conditions and abundance of flammable material led to fire burning through in less than 20 minutes. There were 146 deaths.

#### Lesson Learned and Code Related Issues

There were many inadequacies in this building. Some exits were locked from the outside, there were only 2 staircases and 2 elevators failed. Fire department ladders could not reach top floors, the standpipe hose line was rotted, and the sole fire escape collapsed. Code changes required: fire-proofing, sprinkler systems, improved exiting from high-rises. This led to creation of NYC Bureau of Fire Protection, enforcement of fire codes and fire drills. Led to NFPA 101, The Life Safety Code, and Labor Law reforms.

### **2. AOL Time Warner Tower Fire, NYC (April, 2003)**

#### Fire Summary

The AOL Time Warner Center, when construction is complete, was damaged by a fire that spread to four floors. The floor areas are used for the future Lincoln Center Performing Arts and rehearsal Complex. 13 firefighters were hurt during this four-alarm fire. Another man was treated for injuries at the scene.

#### Lesson Learned and Code Related Issues

Buildings Department inspectors who were at the tower said the source of the fire appeared to be either a space heater or a device known as a salamander, which is used to harden concrete. It is unlawful to use a coke-fueled salamander at a construction site in an occupied building. Any space heater must be used at least 5 feet from combustible decorations and combustible overhangs, awnings, sun control devices or similar combustible attachments to buildings or structures. A C of F is now needed for use of salamander heaters.



### **3. 130 Liberty Street Fire, NYC (August, 2007)**

#### Fire Summary

Fire started from a lit cigarette broke out on the 17th floor of 130 Liberty Street, the former Deutsche Bank building. A hulking remnant of the 9/11 attacks, the building contained toxic dust and had been partially demolished when the blaze occurred, spreading to 13 floors. It grew to seven alarms and resulted in the deaths of two FDNY Firefighters. One hundred other firefighters who responded that day were injured.

#### Lesson Learned and Code Related Issues

The sprinkler system and the standpipe system required by code was out of service. The means of egress (A & B Stairways) required by code were blocked by sealed wooden platforms that prevented members from dropping down below the fire. The stairway enclosures required by code had either been compromised or removed at several locations. New laws strengthened requirements for the inspection and maintenance of standpipes and sprinklers in buildings under construction or demolition and helped ensure that fire sprinklers and standpipes work when needed. The DOB also implemented changes to enhance the effectiveness of its inspections.

*\*Note: These landmark changes help to save lives and property today. In December 2016, a two-alarm fire requiring over 100 FDNY firefighters erupted at a construction site at an NYU Langone Medical Center building in Manhattan. Because the standpipe system in the early stage of construction had been installed, firefighters were able to successfully tap into a water supply via a functioning standpipe, allowing them to control the fire in under an hour. The 500 construction workers on the site at the time of fire evacuated promptly and safely. There were no injuries.*



#### **4. 510 Madison Ave Construction fire, NYC (February, 2009)**

##### Fire Summary

A fire broke out overnight causing some cosmetic damage to the 30-story building. Curtain walls were blown out, and mullions were melted away.

##### Lesson Learned and Code Related Issues

The fire seemed to be electrical in nature. Firefighters had some trouble reaching the second floor of the building under construction. It was found that there was improper storage of construction materials with violations to the Fire Code.



#### **5. Throgs Neck construction fire, NYC (July, 2009)**

##### Fire Summary

More than 130 firefighters, including boat crews, were called in to fight a fire that broke out in the construction area beneath the Throgs Neck bridge Friday morning. The authorities had to close the bridge to traffic in both directions, cutting off a major artery between the Bronx and Queens that carries 112,000 vehicles on an average day.

##### Lesson Learned and Code Related Issues

The fire was caused by a construction worker's blow torch. Heavy timbers located directly below the bridge that had been used as a safety platform for construction workers caught fire. The precautions of hotwork are not followed. The importance of fire guards for hot work operation must be emphasized.



## **6. Avalon Fire, Edgewater, NJ (January, 2015)**

### Fire Summary

The fire was reported around 4:30 p.m. More than 250 firefighters from nearly three dozen communities responded, including fireboats from the New York City Fire Department. Miraculously, no one was injured, but the fire wrecked The Avalon at Edgewater complex, destroying 240 of the complex's 408 units.

### Lesson Learned and Code Related Issues

Two unlicensed maintenance workers were using a blowtorch to perform plumbing repairs in a first-floor apartment at about 4 p.m. when the fire began inside a wall. Instead of immediately calling 911, the workers first phoned their supervisor, leading to a 15-minute delay in the emergency response. The New Jersey state Fire Safety Commission formed a committee to review fire risks associated with multiple dwelling structures constructed with lightweight wood frames. And the NJ state updated new requirements for sprinkler systems in attics and similar spaces and a fire watch during nonworking hours for all construction sites that are at least 40 feet tall.



### **7. Dorchester complex construction fire, Boston, MA (June, 2017)**

#### Fire Summary

The fire began around 2:30 p.m. and grew to a 6-alarm response over the next hour. Air conditioning units on the top of the building buckled and collapsed onto the top floor. It's lightweight construction, which makes it very dangerous for the firefighters to fight the fire. The building cost \$45 million in total development.

#### Lesson Learned and Code Related Issues

The fire was caused by an improperly installed exhaust pipe. The exhaust pipe was between the top floor and the roof, and it was located too closely to combustibles. There is supposed to be a 12-inch clearance, but it was more like three inches. The fire began in the space between the sixth floor and the roof when hot exhaust piping from a generator that was being tested ignited combustible material. Another main issue was the delay in notification of the fire. The construction site worker who smelled smoke but waited an hour and a half to call the Fire Department.



### **8. Fairfax building construction fire, Alexandria, VA (February, 2020)**

#### Fire Summary

The blaze began on the top floor. The wind conditions made the fire difficult to control. More than \$48.2 million in damage to two dozen homes, townhouses and apartment buildings.

#### Lesson Learned and Code Related Issues

A worker at the construction site saw a fire in a trash chute. The fire was caused by improperly disposed smoking materials. The no-smoking policy must be strictly enforced.

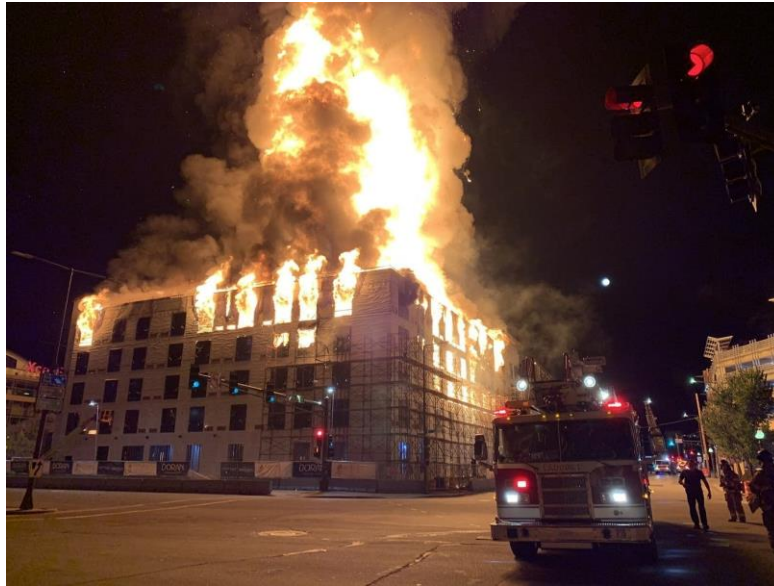

## **9. St. Paul Hotel Construction Site Fire, St. Paul, MN (August, 2020)**

### Fire Summary

The flames began at around 4 a.m. at a still-under-construction building. The five-story hotel portion of the \$69 million luxury apartment/hotel project sustained the majority of the damage.

### Lesson Learned and Code Related Issues

The fire was intentionally set and it's being investigated as an arson. The importance of the watchperson afterhours must be emphasized.

### **Sources**

Arnold, Jim. "Large Building Fires and Subsequent Code Changes". April 7, 2005.

FDNY: Worker's blow torch started Throgs Neck fire. (2009, July 13). *Newsday*.

Fire is Latest Setback at AOL Time Warner Tower at Columbus Circle. (2003, April 9). *The New York Times*.

Investigation of Administrative Issues Relating to the Fatal Fire of August 18, 2007 at 130 Liberty Street. (June, 2009) [https://www1.nyc.gov/assets/doi/reports/pdf/2009/2009-06-19-Pr\\_db\\_final.pdf](https://www1.nyc.gov/assets/doi/reports/pdf/2009/2009-06-19-Pr_db_final.pdf)

Saporito, Anthony. "10 years later- Remembering the Deutsche Bank Fire". July, 2017.

Boston fire chief blasts construction workers for slow response to blaze.(2017, July 26). *Boston Herald*.

'Smoking Materials' Caused Fairfax County Fire That Did \$48M in Damage. (2020, February 13). *NBC4 Washington*.

ATF: Fire that destroyed St. Paul hotel project was arson. (2020, August 12). *ABC News*.

The NFPA 2020 report, "Fires in Structures under Construction or Renovation", found that between 2013-2017 in the US:

- An estimated average of 3,840 fires in structures under construction and 2,580 fires in structures under major renovation per year.
- Fires in structures under construction caused an average of:

- 4 civilian deaths,
  - 49 civilian injuries, and
  - \$304 million in direct property damage annually.
- Fires in structures under major renovation caused an average of:
    - 8 civilian deaths,
    - 52 civilian injuries, and
    - \$104 million in direct property damage annually.

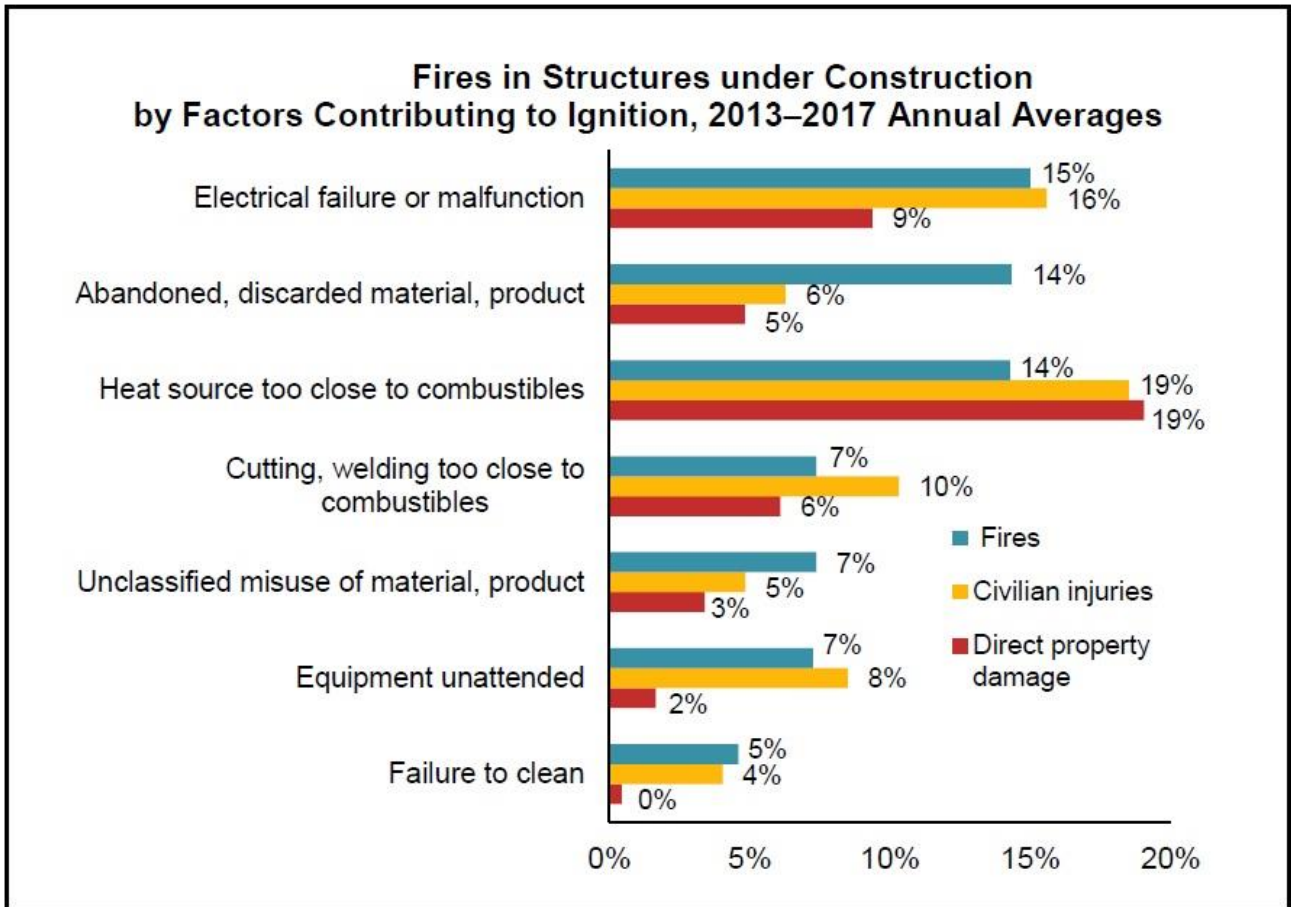

The leading factors contributing to the ignition of fires in structures under construction, as shown in the figure above, included

- electrical failures or malfunctions,
- abandoned or discarded materials or products,
- heat sources too close to combustible materials,
- cutting or welding too close to combustible materials,
- unclassified misuse of materials or products,
- unattended equipment, and
- failure to clean.

Housekeeping practices at construction sites can ensure that **waste and trash materials are stored away from ignition sources and structures**. Additional

good worksite practice should provide for **regular maintenance of equipment** and **establish fire safety procedures for the storage and handling of powered equipment**.

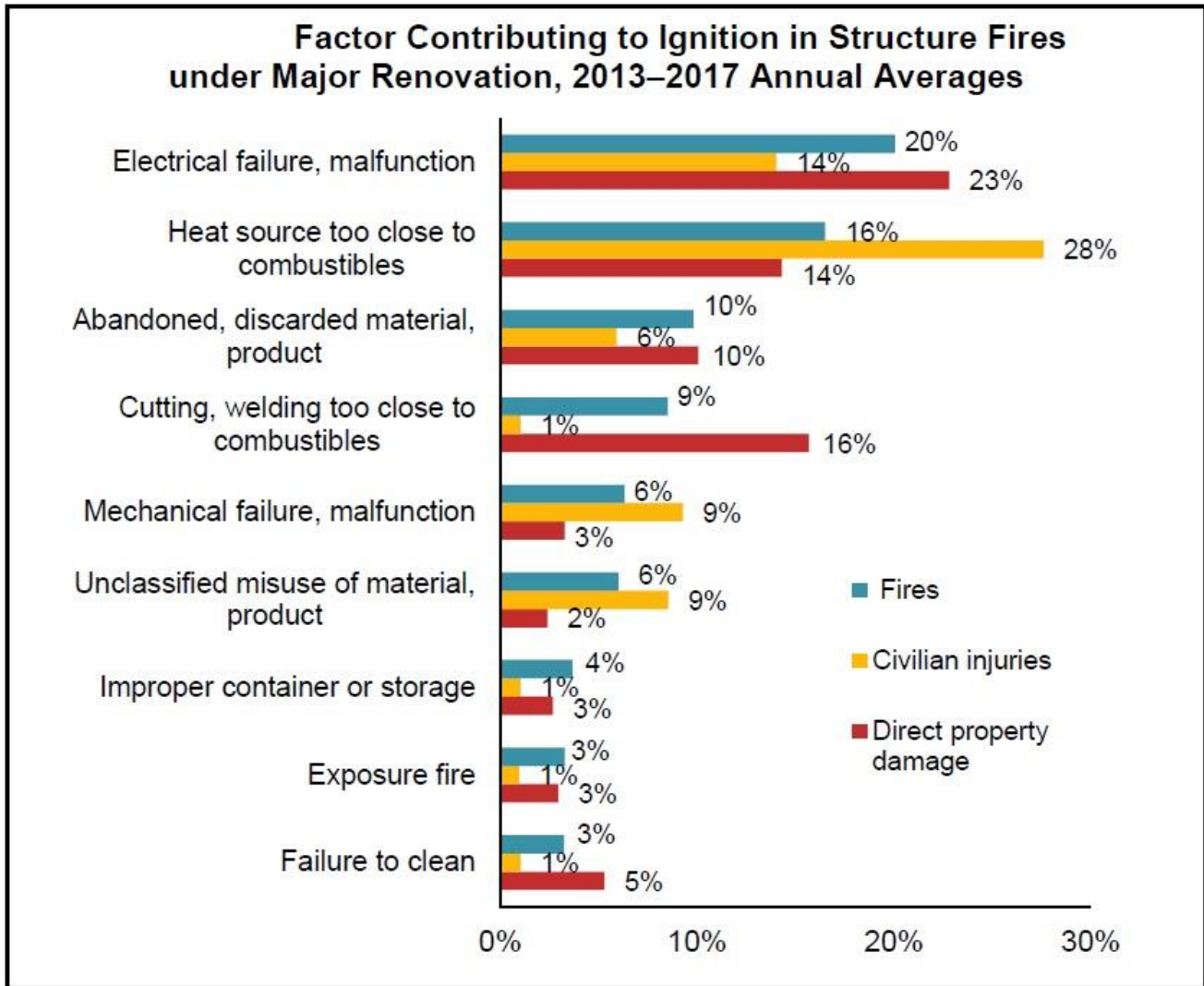

The leading factors contributing to the ignition of fires in structures under major renovation included

electrical failures or malfunctions (20 percent) and heat sources too close to combustible materials (16 percent). The latter accounted for over one-quarter of injuries, as indicated in Figure above.

Abandoned or discarded materials or products were a factor in 10 percent of fires, underscoring again the importance of housekeeping efforts and proper storage of materials at work sites that could pose fire hazards.

Cutting or welding too close to combustible materials accounted for 9 percent of fires, these fires accounted for 16 percent of direct property damage.

The report suggests some safety protocols to reduce the risk of fire:

- Ensuring that temporary electrical service lighting follows installation requirements set forth in the *National Electrical Code*®, that electrical equipment is maintained and regularly inspected, that use of extension wiring is kept to a minimum, and that machinery and equipment do not overload available circuits.
- Prohibiting the use of temporary cooking equipment (such as hot plates or grills) or the use of improvised heating devices for warming food at the construction site.
- Ensuring that unauthorized temporary heaters are restricted from the worksite, that heaters permitted on the worksite are placed at safe distances from combustible and flammable materials and used in conformity with manufacture instructions, and that heaters are regularly checked to ensure that they are being safely operated and do not constitute a hazard (such as being overturned).
- Requiring a permit system for hot work activities and enforcing a thirty-minute (or longer) cool-down interval following use of torches, burners, or soldering irons.
- Reducing the risk of arson by safeguarding construction sites with fencing or other controls, such as lighting or after-hours security personnel, as needed.

Guidance for preventing fires at structures under construction or undergoing renovation is available in *NFPA 241, Standard for Safeguarding Construction, Alteration, and Demolition Operations*.

Other detail in the report could be found:

<https://www.nfpa.org/-/media/Files/News-and-Research/Fire-statistics-and-reports/Building-and-life-safety/osFiresInStructuresUnderConstruction.pdf>

## **CHAPTER 1. ROLE AND RESPONSIBILITIES**

### **1.1 Designation of Construction Site Fire Safety Manager**

Where a Site Safety Manager or Site Safety Coordinator is required by the Building Code, the owner shall designate a person to be the Construction Site Fire Safety Manager (CSFSM).

Exception: Construction sites at which an existing building is undergoing alteration, the alteration work is limited to the façade, and no hot work is being performed.

- Such person shall hold a S-56 Certificate of Fitness as a CSFSM.
- The CSFSM may be the Site Safety Manager or Site Safety Coordinator required by the Building Code

Exception: A separate CSFSM shall be designated for a building under construction when such building reaches a height of twenty stories or more than 250 feet, has a lot coverage of 200,000 square feet or greater.

- The CSFSM shall be present at the construction site at all times when construction, alteration and demolition work is being conducted. The fire safety manager shall sign in the logbook required at the beginning and end of each workday.
  - An alternate fire safety manager shall assume the duties and responsibilities of the fire safety manager whenever the fire safety manager is required to be present at the construction site but is absent.

### **1.2 The duties of Construction Site Fire Safety Manager (CSFSM)**

(The following duties only include the requirements from the Fire Code/Fire Rules, if you also serve as a Site Safety Manager or Site Safety Coordinator, you need to be familiar with the Building Code requirements to perform the required different duties.)

The Construction Site Fire Safety Manager must:

- develop and maintain at the construction site an approved Pre-Fire Plan. Any changes in site conditions materially affecting the procedures set forth in such plan must be updated in the pre-fire plan, maintained at the construction site and readily available for the FDNY upon FDNY's request;
- ensure the construction site in compliance with the requirements of the Fire Code and the Fire Rules;
- supervise and/or monitor materials, operations and facilities regulated by the Fire Code;
- conduct an inspection of the construction site and all fire safety measures on at least a daily basis;
- ensure that construction site personnel are acquainted with the operation of portable fire extinguishers and other fire protection equipment on the construction site;
- ensure that all fire protection equipment and systems are readily available and periodically inspected and tested, and maintained in accordance with this code, the rules and the Building Code;



- be responsible for the general supervision of the fire guards where fire watch service is provided. The CSFSM shall perform the duties of the responsible person for hot work operations and be responsible for supervising the issuance of authorizations for hot work operations;
- perform the duties of the Impairment Coordinator when any required fire protection system is out of service at the construction site;
- perform the duties of the Fire Department liaison;
- provide or arrange Fire Department access to the construction site, inspection of the logbook and other records, and communication with the owner or his or her design professionals, managers or contractors;
- take all other actions that a prudent person trained and knowledgeable in construction site fire safety would take to ensure that fire safety is maintained at the construction site, given site conditions; and
- maintain a record of same in a bound log book or other approved system of recordkeeping.

## **CHAPTER 2. PREPARATION**

### **2.1 Pre-Fire Plan for Construction Site**

The Construction Site Fire Safety Manager (CSFSM) shall develop and maintain at the construction site an approved Pre-Fire Plan, and make it available for examination by any representative of the Fire Department.

If the site safety plan is required for the construction site, the CSFSM should be familiar with the approved site safety plan. The information in the site safety plan should be consistent and included in the Pre-Fire Plan.

The Pre-Fire Plan shall be in a narrative with explanatory drawing. Any changes in site conditions materially affecting the procedures set forth in such plan must be updated in the pre-fire plan, maintained at the construction site and readily available for the FDNY upon FDNY's request.

The purpose of the plans is to establish a method of systematic, safe and orderly evacuation of an area and of its construction site personnel in case of fire or other emergency, in the least possible time to a safe area or by the nearest safe means of egress. It is also to ensure the readiness and use of available fire protection equipment.

The main goal of the Pre-Fire Plan is to gather general and detailed data of the construction site conditions and provide them in a condensed format for use by the site personnel in the event of an emergency. The Pre-Fire Plan should include site specific evacuation procedure and site specific emergency contact procedure.

Plans shall identify all standpipe risers, cross connections, fire department connections, any intermediate check valves that have to be removed, proposed location of the air release connections, designation of the supervisory pressure, complete information regarding the alarm system, and procedures for the safe pressurization and depressurization of the system.

Sample of the Pre-Fire Plan is listed below:

#### **Pre-Fire Plan**

This narrative should accompany the required drawing. The Pre-Fire Plan should indicate:

1. Building Address: \_\_\_\_\_ Zip Code \_\_\_\_\_

Type of Construction: \_\_\_\_\_ Combustible \_\_\_\_\_ Non-Combustible \_\_\_\_\_

Height of the current construction: \_\_\_\_\_

Number of current floors \_\_\_\_\_ Aboveground \_\_\_\_\_ Belowground \_\_\_\_\_

2. Building ownership information: \_\_\_\_\_

2.1 Contact Business/ Cell No: \_\_\_\_\_

3. Construction Site Fire Safety Manager (CSFSM)

3.1 Name \_\_\_\_\_

Business/ Cell No. \_\_\_\_\_

3.2 C of F # \_\_\_\_\_ Exp date: \_\_\_\_\_

Site Safety Manager (SSM) / Site Safety Coordinator (SSC)

3.3 Name \_\_\_\_\_

Business/ Cell No. \_\_\_\_\_

3.4 License / C of F # \_\_\_\_\_ Exp date: \_\_\_\_\_

Construction Project Manager

3.5 Name \_\_\_\_\_

Business/ Cell No. \_\_\_\_\_

4. Emergency Procedures

4.1 A sketch indicating the evacuation procedures and path for site personnel to follow (Updated as site conditions change)

Date of most recent update: \_\_\_\_\_

4.2 Location of all marked evacuation exits.

4.2.1 Available stairways for an emergency evacuation

1. \_\_\_\_\_ 3. \_\_\_\_\_

2. \_\_\_\_\_ 4. \_\_\_\_\_

4.2.2 Location of any limited access and egress points.

1. \_\_\_\_\_ 3. \_\_\_\_\_

2. \_\_\_\_\_ 4. \_\_\_\_\_

4.2.3 Any other type of access and egress points:

1. Type of Egress \_\_\_\_\_

2. Identification \_\_\_\_\_

3. Location \_\_\_\_\_

4. Leads to \_\_\_\_\_

4.3 Means of notification to site personnel:

i.e.: Air horn with repetitive horn blasts

i.e.: Three second horn blasts with a 10 second pause repeated as necessary All clear is a 10 second continuous horn blast.

i.e.: Audible sound will alert site personnel that an evacuation is required.

4.4 Specific procedures for the safe evacuation of the construction site:

4.4.1 Head count of all building trade workers on the site \_\_\_\_\_.

4.4.2 Personnel for hoist/elevator operation \_\_\_\_\_.

4.4.3 Site superintendent to search building.

4.5 The location of “MUSTER POINT” outside construction site where all building trade workers must report to in the event of a total site evacuation. (Note: personnel shall be notified not to wander off or leave unless instructed to by their supervisor).

---

5. Evacuation Drills (*recommended quarterly*)

5.1 Conduct fire drill and evacuation drills.

5.2 Frequency of drills – indicate start date and frequency \_\_\_\_\_.

5.3 Head count of all building trade workers participated \_\_\_\_\_.

6. Not limited but required signage

6.1 *Exits signs including signs on the floor that leads to exits (Best practice)*

6.2 Extinguishers locations

6.3 Location of standpipe system and Fire Department connections.

6.4 Location of fire hydrant and other forms of fire protection

6.5 FDNY location of “Muster Point”

6.6 Storage of flammable solids, liquids and/or gases.

6.7 Stair case and means of egress.

7. Communications systems like walkie-talkies telephones etc.

7.1 \_\_\_\_\_

7.2 Automatic Dialer

8. Fire Protection equipment

8.3 Extinguishers

How many \_\_\_\_\_

Location \_\_\_\_\_

9. Prepared/revised by \_\_\_\_\_

9.1 Date prepared: \_\_\_\_\_ 9.2 Date revised: \_\_\_\_\_

Figure 2-1 Site Specific Evacuation Plan

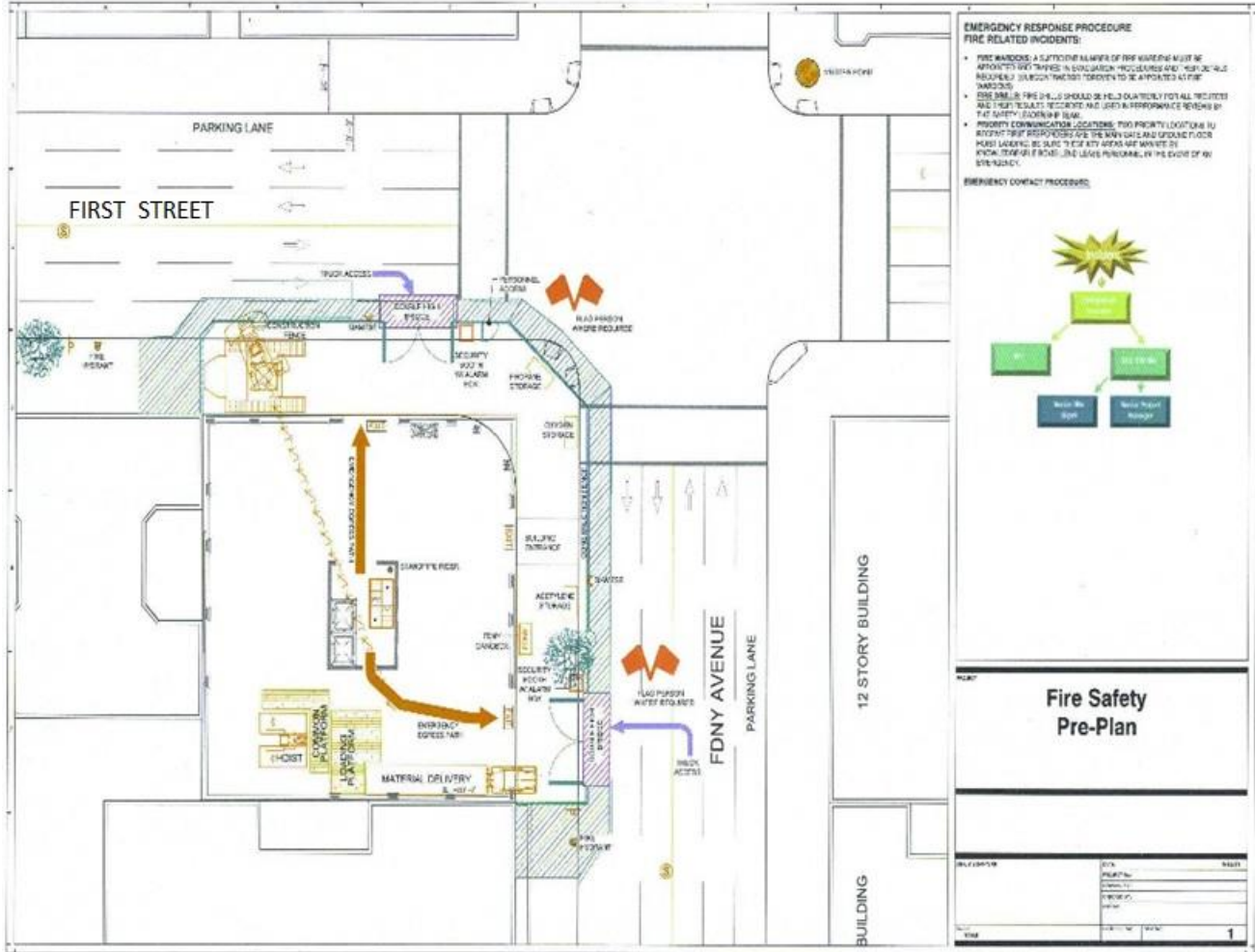

**2.2 NFPA 241 Construction Fire Safety Program (best practice)**

NFPA 241 suggests an overall construction/demolition fire safety program shall be developed and addressed the following items:

- (1) Good housekeeping
- (2) On-site security
- (3) Fire protection systems, as follows:
  - (a) For construction operations, installation of new fire protection systems as construction progresses
  - (b) For demolition operations, preservation of existing fire protection systems during demolition
- (4) Organization and training of an on-site fire brigade, where applicable
- (5) Development of a Pre-Fire Plan with the local fire department
- (6) Rapid communication
- (7) Consideration of special hazards resulting from previous occupancies
- (8) Protection of existing structures and equipment from exposure fires resulting from construction, alteration, and demolition operations

### **2.3 Training**

The CSFSM shall ensure that construction site personnel are acquainted with the operation of portable fire extinguishers and other fire protection equipment on the construction site.

The training should also include the following information:

- Locations and requirements of portable fire extinguishers.
- Other fire protection equipment.
- Non-smoking policy.
- How to properly report fire and other emergency.
- The fire and emergency response procedures to safeguard life and property.

The hot work related personnel should also receive additional training regarding hot work requirements.

The CSFSM should ensure that the watchperson and any responsible person who may be on site to supervise the construction site are familiar with all information on the Pre-Fire Plan. The CSFSM should ensure these construction site personnel know all detailed data of the construction site (e.g. the site specific evacuation procedure, emergency contact procedure, and the locations/layout of the fire protection systems, the locations of any hazardous materials, etc.) so the personnel can immediately provide the information to the first responders. The CSFSM should also ensure the personnel have the most updated information from the Pre-Fire plan.

**CHAPTER 3. FDNY PERMIT, CERTIFICATE OF FITNESS****3.1 Construction Site Relevant Certification of Fitness List**Table 3-1. Construction Site Relevant Certification of Fitness List  
(This table will be provided as a reference material in the FDNY CBT exam)

<b>Type</b>	<b>Description</b>	<b>Personal/General</b>
A-49/W-49	A-49: Supervision of Storage, Handling and Use of Aerosol W-49: Supervision of Storage, Handling and Use of Aerosol at Construction Site only.(Citywide)	Use: Personal Storage: General
B-03	Testing of In-Building Auxiliary Radio Communication Systems (Citywide)	Personal
C-30	Supervision of Flammable/Combined Finishing Operations.	Personal
E-21	Storage and Use of Powder Actuated Tools (Citywide)	Use: Personal Storage: General
F-01	Fire Guard for Impairment (Citywide)	Personal
F-60	Fire Guard for Torch Operation (Citywide)	Personal
G-40	Use of LPG/CNG for Tar Kettles, Asphalt Melter and Marking Street Line (Citywide)	Personal
G-41	Use of LPG/CNG for Torch-Applied Roof Systems (Citywide)	Personal
G-42	Use of LPG/CNG for All Roofing Operations (Citywide)	Personal
G-44/W-44	G-44: Storage and Handling of LPG/CNG W-44: Storage and Handling of Oxygen, LPG/CNG and Acetylene at Construction Site Only. (Citywide)	Handling: Personal Storage: General
G-60	Use of Flammable gases with Oxygen or Use of LPG/CNG for Hot Work Operations (Citywide)	Personal
P-54	Crane Aerial Fueling Operations at Construction Site (Citywide)	Personal/General
S-12/S-15	Supervision of Sprinkler System (Citywide) / Supervision of Foam-water Sprinkler Systems (Citywide)	Personal
S-60	Watchperson at construction sites	Personal
S-92	Supervision of Portable Fueled Space Heaters at Construction Site (Citywide)	Personal
S-93	Supervision of Temporary Storage, Handling and Dispensing Flammable or Combustible Liquids at Construction Sites (Citywide)	Personal/General
S-97/S-98	of Fire Alarm System Inspection, Testing and Servicing (Citywide)	Personal
W-97	Supervision of Fumigation & Fogging Operations (Citywide)	Personal
W-96	Full Service Shop of Portable Fire Extinguishers (Citywide)	Personal

### **3.2 FDNY permits**

Contact the CDA unit to do permit inspection for storing, handling and using hazardous materials/equipment at construction sites.

Contact the FDNY District Office (refer to Appendix A) depending upon the location of the site or building to arrange a permit inspection for installing specific equipment, such as sprinkler and/or standpipe systems, boiler, generators, etc.

#### 3.2.1 Three types of FDNY permits

##### (1) Site-specific permit

Such permit authorizes the permit holder to manufacture, store, handle, use or sell hazardous materials or combustible materials, or conduct an operation or maintain a facility at a specific premises or location, for which a permit is required by the Fire Code.

A site-specific permit may be a **permanent** permit or a **temporary** permit.

- Permanent permits are valid up to 12 months only. Every permit or renewal shall require an inspection and shall expire after twelve months.
- Temporary permit may be valid from one day to 12 months depends on the construction /operation need. For example, a one-week temporary permit may be issued for construction work which only takes one week. Normally, hot work operation (e.g. construction site or hot work repair) is issued a temporary permit.





**FIRE DEPARTMENT**  
9 METROTECH CENTER  
BROOKLYN, N.Y. 11201-3837

**BUREAU OF FIRE PREVENTION**



\* F 0 2 8 8 4 \*

**CONSTRUCTION, DEMOLITION, AND ABATEMENT UNIT PERMIT**

PERMIT #	PERMIT CATEGORY	ACCOUNT #	COMPANY	DO #	DIV #
F7777777	ALTERATION	88888888	X01	50	03

**PERMIT TYPE** | CHANGE IN COVERAGE

**PERMIT HOLDER**  
ABCD Construction, INC.  
**MAILING ADDRESS**  
1 BBB AVENUE, BRONX, NY 10475

ISSUE DATE	EXP. DATE	BOROUGH	INSPECTED BY	INSP. TIME	TOTAL FEE	BIN #
2/12/2021	10/6/2021	MANHATTAN	192	90 MIN	\$630	1111111

**PREMISES/LOCATION ADDRESS**

**3 AAA DR, MANHATTAN 10023**

CODE #	PERMIT COVERS	QTY	PRICE
345-00	COMPRESSED Gases Only- Oxygen Storage (Number of Cages)	1 Cage(s)	\$210
346-00	ACETYLENE STORAGE (Number of Cages)	1 Cage(s)	\$210
347-00	USE OF OXYGEN/COMP. GAS(ES) FOR TORCHWORK (For use at site, not # of operators)	1	\$105
373-00	A/C UP TO 3 UNITS Air Compressors	1	\$105

**COMMENTS**

Pursuant to the provisions of the administration Code and the regulations made thereunder, the above permittee is hereby authorized by the Fire Commissioner to store and use HAZARDOUS MATERIALS in the quantities specified.

This permit is revocable at the pleasure of the Commissioner, and is issued with the express understanding that the articles herein named are to be stored and kept in accordance with the provisions of the law; that the permittee will use all possible care to avoid accidents; that it is only available for the location and permittee named.



**FIRE COMMISSIONER**

The New York City Fire Code (FC105.35) requires that Permits be posted in a conspicuous location on the Premises, or maintained on the transport Vehicle at all times, and be readily available for inspection by any Representative of the Department.

Page 1 of 1

Figure 3-1. Example of a permanent FDNY Site Specific Permit

(2) Citywide permit.

Such permit authorizes the permit holder to store, handle, use or sell hazardous materials, or conduct an operation on a citywide basis, for which a permit is required by the fire code. A citywide permit is valid to temporarily store, handle, use or sell hazardous materials or to conduct an operation at one or more locations subject to the following restrictions:

- The duration of such activity at any individual location does not exceed 30 calendar days and all hazardous materials associated with such activity are removed from the location at the end of the workday. Periods of activity in excess of 30 calendar days at any one location shall require a site-specific permit.
- The quantity of hazardous materials being temporarily stored and used does not exceed 5 gallons of gasoline, or 250 gallons of any other flammable liquid, and 300 gallons of any combustible liquid. Storage or use of hazardous materials in quantities exceeding these amounts requires a site-specific permit for each location at which such storage or use occurs.

(3) Transportation permit.

Such permit authorizes the permit holder to transport, pick up and deliver hazardous materials. Any person who transports any hazardous material in the quantity of requiring a FDNY permit has to apply for a FDNY transportation permit. The FDNY transportation permit (sticker) must be displayed on the vehicle.

Figure 3-2. Example of a FDNY transportation permit (a sticker)

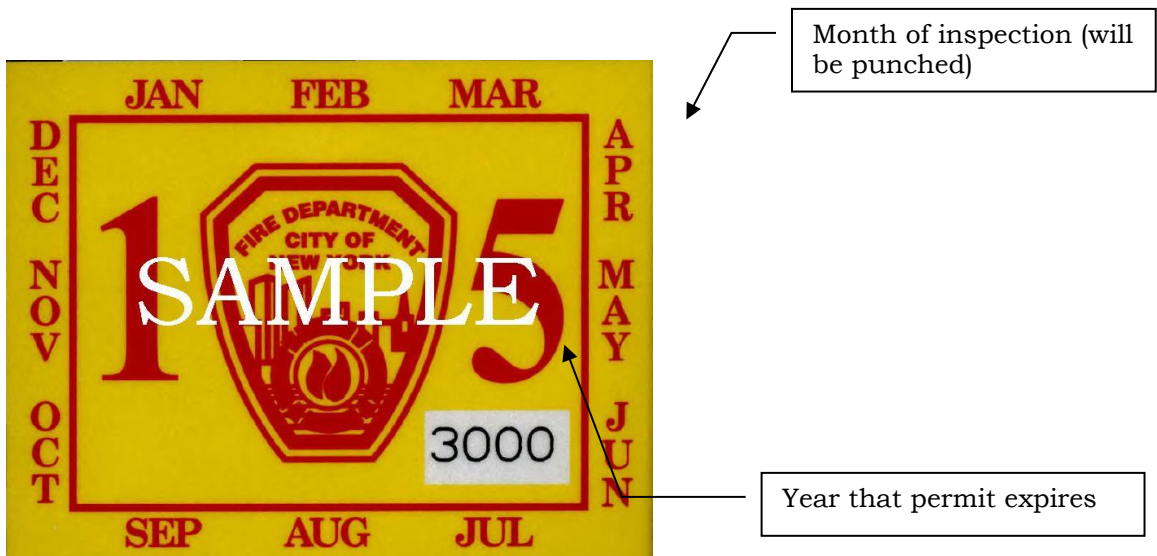

### 3.2.2 Common FDNY Permits and related C of Fs at Construction Sites

Table 3-2. Common FDNY Permits and related C of Fs at Construction Sites  
(This table will be provided as a reference material in the FDNY CBT exam)

<b>Material /Facility</b>	<b>Permit requirements</b>	<b>C of F</b>	<b>Note</b>
Aerosol products	A permit is required to store, handle or use an aggregate quantity of Level 1, 2 or 3 aerosol products in excess of 100 pounds (45.4 kg) net weight.	W-49	A-49 is acceptable but W-49 is preferable since W-49 is used for citywide construction site.
Air compressor	Compressing a nonflammable, corrosive or oxidizing gas, including air, to a pressure exceeding 100 psig.	A-35/ G-35	
Asphalt melter	FDNY permit is also required to store, handle or use an asphalt melter.	G-40/ G-42	<ul style="list-style-type: none"> <li>• G-40: Use of LPG/CNG for Asphalt Melter or Tar Kettle</li> <li>• G-42: Use of LPG/CNG for All Roofing Operations (asphalt melter, tar kettle and torch-applied roof systems)</li> </ul>
Coke-fueled salamanders	A permit is required to store, handle or use coke-fueled salamanders at a construction site.	S-92	
Combustible material storage	A permit is required to store in any building, structure, premises or facility more than 2,000 cu-ft gross volume of combustible empty packing cases, boxes, barrels or similar containers, rubber (excluding tires), cork or similar combustible material, including combustible waste, or more than 1,000 pounds of flammable plastic foam products, regardless of volume.	N/A	
Flammable compressed gases (e.g. acetylene)	The storage, handling and use of compressed flammable gas above 400 SCF (standard cubic feet) requires a permit.	G-44/ W-44	<ul style="list-style-type: none"> <li>• G-44 is acceptable but W-44 is preferable since W-44 is used for citywide construction site.</li> </ul>

Floor finishing	A permit is required to conduct floor finishing or surfacing operations over an area exceeding 350 square feet (33 m <sup>2</sup> ) using Class I or Class II liquids.	C-30	
Hot work operations	A permit is required to conduct hot work using oxygen and a flammable gas, such as acetylene or propane.	G-60/ G-41/ G-42/ F-60	<ul style="list-style-type: none"> <li>• G-60: Use of Flammable Gases with Oxygen or Use of LPG/CNG for Hot Work Operations</li> <li>• G-40: Use of LPG/CNG for Asphalt Melter or Tar Kettle</li> <li>• G-41: Use of LPG/CNG for Torch-Applied Roof Systems</li> <li>• F-60: Fire Guard for Torch Operations.</li> </ul>
Liquefied Petroleum Gas (LPG)	Store or handle liquefied petroleum gas in quantities exceeding 400 SCF (47 pounds of LPG).	G-44/ W-44 G-40/ G-41/ G-42/	<ul style="list-style-type: none"> <li>• G-44 is acceptable but W-44 is preferred since W-44 is used for citywide construction site.</li> <li>• G-40: Use of LPG/CNG for Asphalt Melter or Tar Kettle</li> <li>• G-41: Use of LPG/CNG for Torch-Applied Roof Systems</li> <li>• G-42: combine G-40 and G-41</li> </ul>
Oxidizing compressed gases (e.g. oxygen)	Store, handle or use oxidizing compressed gases in quantities exceeding 504 SCF.	G-44/ W-44	<ul style="list-style-type: none"> <li>• G-44 is acceptable but W-44 is preferred since W-44 is used for citywide construction site.</li> </ul>
Small arms ammunition	Permits are required to store or sell 200 or more shells of power actuated magazine strips or cartridges.	E-21	
Tar kettles	A permit is required to store, handle or use a tar kettle.	G-40/ G-42/ S-93	<ul style="list-style-type: none"> <li>• G-40: Use of LPG/CNG for Asphalt Melter or Tar Kettle</li> <li>• G-42: Combine G-40 and G-41</li> <li>• S-93 Certificate of Fitness for a diesel fueled tar kettle.</li> </ul>

<p>Temporary storage and dispensing flammable and combustible liquids at construction sites (gasoline or diesel or motor oil or flammable or combustible paint/lacquer/varnish)</p>	<p>Store, handle or use:</p> <ol style="list-style-type: none"> <li>1. Class I liquids, other than paints, varnishes, lacquers, gasoline and other petroleum-based Class I liquids, in quantities exceeding 5 gals.</li> <li>2. Gasoline and other petroleum-based Class I liquids other than paints, varnishes and lacquers, in quantities exceeding 2½ gals.</li> <li>3. Class II or Class III liquids with a flash point of 300°F or less, other than paints, varnishes and lacquers, in quantities exceeding 10 gals.</li> <li>4. Class I, Class II or Class III liquids having a flash point of 300°F or less that are commonly used for painting, varnishing, staining or other similar purposes, including paint, varnish and lacquer, in quantities exceeding 20 gals.</li> <li>5. Fuel oil in quantities exceeding 10 gallons on mobile heating and power generating trailers.</li> </ol>	<p>S-93</p>	
<p>Portable fueled space heaters</p>	<p>A permit is required to store, handle or use portable fueled space heaters that are fueled:</p> <ol style="list-style-type: none"> <li>1. by a combustible liquid.</li> <li>2. by compressed natural gas (CNG).</li> <li>3. by liquefied petroleum gas (LPG).</li> <li>4. by piped natural gas, except in Group R-3 occupancies.</li> </ol>	<p>S-92</p>	<p>A FDNY permit is required to store a combustible liquid (i.e. kerosene) in excess of 10 gallons. However, a Fire Department permit is required when there is more than 2 ½ gallons of gasoline on site. In addition to the heater, a separate permit shall be required for storage &amp; use of LPG, kerosene etc.</p>

## **CHAPTER 4. FIRE PROTECTION SYSTEMS**

The Fire Safety Manager must ensure that all fire protection equipment and systems (e.g. standpipe system, fire department connection, air pressurized alarm system, sprinkler system, and fire extinguishers) are readily available and periodically inspected and tested, and maintained in accordance with the NYC Fire Code, the NYC Fire Rules and the NYC Building Code. The detail information is also provided in chapter 4 and chapter 5 of this booklet.

### **4.1 Water Supplies**



Figure 4-1. Water Supply

An approved water supply for fire protection, either temporary or permanent, shall be made available prior to hazardous materials or combustible material arriving at the site. Any water source intended for firefighting operations, including standpipe outlets, street hydrants and yard hydrants, must not be used for construction, alteration or demolition purposes, unless approved by the NYCDEP. The NYCDEP permit needs to be kept on site and shall be available upon requested. The CSFSM must ensure that approved backflow preventer is installed to protect the public water from contamination or pollution.

According to Building Code section 3303.7.1.1 a building that has a footprint of 100,000 square feet or more (regardless of height), a permanent or temporary fire hydrants must be available for Fire Department use and must be provided during the course of construction:

1. Within 50 feet of the main entrance; and
2. Along the perimeter of the building, with the hydrants located so that there is at least one hydrant along every 250 feet of building perimeter, and with no hydrant more than 50 feet from the exterior wall.

The potable water supply to all sprinkler systems and standpipe systems shall be protected against backflow as required by the construction codes, including the Plumbing Code, and the requirements of the Department of Environmental Protection.

## 4.2 Standpipe System

Standpipe systems are installed in buildings to help firefighting personnel deploy attack hose lines quickly and with adequate water pressure and volume to attack a fire. Standpipe systems consist of a network of fixed piping and hose valve connections that provide a reliable water source to extinguish or control an interior fire in the building.

The Building Department issues Licensed Master Plumber (LMP) licenses to Contractors qualified to perform plumbing, standpipe (for standpipes not connected to sprinkler systems) and sprinkler work (for less than 30 heads). Master Fire Suppression Piping Contractors (A or B) (MFSPC) are authorized to perform all standpipe and sprinkler work. Permits for plumbing and fire suppression work are only issued to an LMP or Master Fire Suppression Piping Contractors (MFSPC). Only these Licensees, or the employees they supervise, may work on piping systems.

### 4.2.1 Standpipe System in Readiness

#### 1. *Standpipe System in New Buildings*

When the working deck reaches a height of 75 feet or greater above the ground in a building for which a standpipe system will be required, a permanent or temporary standpipe system must be installed and shall be kept in a state of readiness at all times for use by fire-fighting personnel.

The standpipe system must serve all floors (including stories below grade) where the permanent or temporary stairs are required. All standpipes in a state of readiness must be painted red. No standpipe shall be considered to be in a state of readiness unless it is painted red in accordance with the provisions of Building Code Section 905.11. When freezing conditions may be encountered, the system in whole, or the part of the system subject to freezing conditions, shall be maintained as a dry system.



Figure 4-2. Standpipe at Construction Site



Figure 4-3. Air Pressurized Standpipe System

## 2. Structures Undergoing a Full Demolition:

The standpipe systems shall be maintained as dry standpipes. At the commencement of demolition, the standpipe risers shall be capped above the outlet on the floor immediately below the floor being demolished so as to maintain the standpipe system on all lower floors for Fire Department use. The CSFSM must ensure cutting and capping of standpipes during demolition work performed only by a Licensed Master Plumber or Licensed Master Fire Suppression Piping Contractor who has obtained a permit for such work. Standpipe hose, nozzles and spanners are not required to be maintained and may be removed at any time.

The red paint shall be maintained during any demolition operations. All existing house check valves shall remain in place until completion of the demolition work.

## 3. Alteration or Partial Demolition Operations in a Building:

In an unoccupied building, an existing wet standpipe system may be maintained as a dry system subject to the approval of the Building Department and FDNY, and also provided the standpipe system is equipped with an air pressurized alarm system. No standpipe shall be considered to be in a state of readiness unless it is painted red.

If the alteration work results in the addition of new stories to the structure at a height of 75 feet greater above the level of the ground, the requirements of Item 1 of this section shall apply to such new stories during the course of the alteration operation.

If the alteration work results in the addition of new occupiable space at a depth of 75 feet or greater below the level of the ground, the requirements of Item 3 of this section shall apply to such new occupiable space below grade during the course of the alteration operation.

### 4.2.2 Fire Department Connections

The standpipe systems shall be kept in a state of readiness at all times for use by fire-fighting personnel. Immediate access to Fire Department connections shall be maintained at all times, without obstruction by fences, posts, bushes, trees, rubbish containers, vehicles, walls or other objects.

Fire department connections shall be kept free from obstruction and shall be marked by a metal sign reading, "Standpipe Connection" and by a red light at night. The FDNY recommends the red light illumination should be provided 24 hours every day. If the sign or the red light is defective, the CSFSM must ensure to fix it immediately.





Figure 4-4. Proper sign and red light provided at the FDNY connection

If the FDNY connections are obstructed by a fence, the fence must have an approved access gate complying with the Fire Department regulation including providing the “standpipe FDNY connections” signage and a means of emergency operation. If any construction site staff observes anyone park or obstruct the FDNY connections, the staff should direct the person to keep the area clear.

A working space of not less than 36 inches in width, 36 inches in depth and 78 inches in height shall be provided and maintained in front of and around wall-mounted and free-standing Fire Department connections.

Where Fire Department connections are subject to impact by a motor vehicle whose normal operation brings it into proximity with such connections, vehicle impact protection shall be provided. The FDNY may require locking caps on Fire Department connections for sprinkler and standpipe systems.

### Fire Department Thread

Fire department connections allow firefighters to pump water to standpipe and/or sprinkler systems, they are critical tools in the event of a fire. Each fire department connection is designed to connect to a hose of a particular kind and size in different cities. Each fire department connection swivel connects only to hoses with couplings of the right size, threading, and gender. New York City has its own specific

standards for hose couplings and fire department connections. Standard FDC threads may not be compatible with FDNY equipment.

Mismatched threading was a major contributor to at least two historic fires: the Great Baltimore Fire of 1904, which destroyed more than 1,500 buildings in Baltimore, MD, and the 1991 Oakland Hills Fire, where incompatible hose and fire hydrant couplings delayed a fight against an Oakland, CA blaze that killed 25 people.

Install the correct type of fire department connections and the particular swivels they use to connect to fire hoses is essential. Each valve has a MEA or BS&A number, the Master Fire Suppression Contractor or the License Master Plumbers who install or change the valves must verify the valves are approved by the FDNY. There are also couplings to attach showing threads that are used by FDNY. The CSFSM must ensure that the installers know the regulations and select the FDNY approved valves.

#### 4.2.3 Main Control Valve

**Main control valve** is the valve that controls the flow of the water from the domestic water supply system and/or fire pump(s). The main control valve is an indicating valve: a fire fighter can tell whether it is open or closed at a glance. The valve is manually operated and, along with other valves, should always be in the open position. The most common type of main water control valve is the OS&Y (Outside Stem & Yoke) valve. It is easy to tell if the OS&Y valve is in the open or closed position. If the stem is raised (OUT) above the control wheel the valve is open. If the stem is flush (IN) with the control wheel the valve is closed.

Another common type of control valve is butterfly valve. These valves use an internal gate to block water. The gate is attached to a visible, external paddle. When this paddle runs parallel the pipe, you know that the valve is open; a perpendicular orientation to the pipe means it's closed.

All OS&Y valve(s) or control valves shall be locked by chain in the open position. Secure a locked chain through the control wheel or handle to prevent physical movement of the valve.

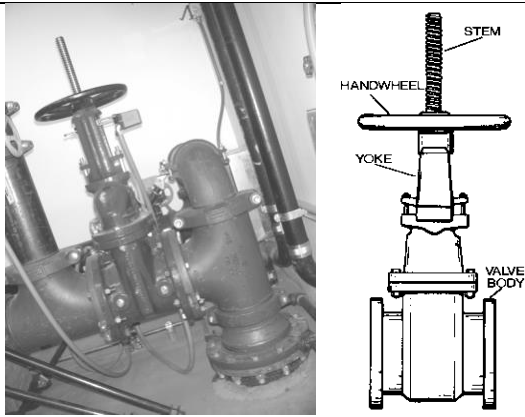

Figure 4-5. Stem is raised = the OS&Y valve is open



Figure 4-6. Stem is flush with the wheel = the OS&Y valve is closed



Figure 4-7. Open butterfly valve.  
(The paddle runs parallel the pipe)



Figure 4-8. Closed butterfly valve.  
(The paddle is perpendicular to the pipe)



Figure 4-9. This OS&Y control valve is locked in open position.



Figure 4-10. This butterfly control valve is locked in open position.

#### 4.2.4 Markings and Color Coding

All exposed standpipe piping, cross connections, and risers shall be painted red or identified by lettered legend as per ANSI A13.1.

Wall hydrants and fire pump test headers located on the exterior of buildings shall be conspicuously marked to indicate their function. Fire Department connections shall be marked as follows:

1. Fire Department connections serving a standpipe system shall be provided with **caps painted red**, and shall have the word “STANDPIPE” in letters 1 inch high and 1/8 inch deep cast in the body or on a non-ferrous metal plate secured to the connections or mounted on the wall in a visible location, except **that caps of Fire Department connections used for combination standpipe and sprinkler systems shall be painted yellow** and the words shall read: “COMBINATION STANDPIPE AND SPRINKLER SYSTEMS.”
2. Fire Department connections serving a sprinkler system protecting an entire building or structure shall be provided with **caps painted green** and shall have the word “SPRINKLER” in letters 1 inch high and 1/8 inch deep cast in the body or on a non-ferrous metal plate secured to the connections or mounted on the wall in a visible location, except **that caps of Fire Department connections used for combination standpipe and sprinkler systems shall be painted yellow** and the words shall read: “COMBINATION STANDPIPE AND SPRINKLER SYSTEMS.”
3. Fire Department connections serving a non-automatic sprinkler system shall have the entire connection painted silver.
4. Fire Department connections serving a sprinkler system protecting only a portion of a building or structure shall have durable metal signs securely fastened to, or above, the connection indicating the portion of the building or structure protected.



Figure 4-11. Fire Department connections serving a sprinkler system protecting an entire building or structure shall be provided with caps painted green. (left)

Fire Department connections serving a standpipe system shall be provided with caps painted red. (right)

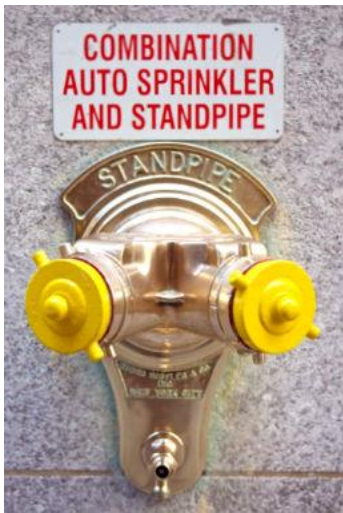

Figure 4-12. The caps of Fire Department connections used for combination standpipe and sprinkler systems shall be painted yellow



Figure 4-13. Fire Department connections serving a sprinkler system protecting only a portion of a building or structure shall have durable metal signs securely fastened to, or above, the connection indicating the portion of the building or structure protected.

#### 4.2.5 Air Pressurized Alarm System for Dry Standpipe Systems

Dry standpipe systems utilized during construction or demolition operations must be provided with an air pressurized alarm system. Where a dry standpipe system is used, the dry standpipe system is filled with pressurized air. No water is available in the system until the FDNY charges the FDNY connection. A License Master Plumber/Master Fire Suppression contractor shall conduct an air pressure or hydrostatic pressure test on all standpipes at such time as the pressure alarm is installed. The air pressurized alarm system to ensure that the standpipe system has no leaks to meet the pressure requirements. The alarm will be activated if the pressure cannot meet the requirements.

In existing buildings undergoing a major alteration, the existing wet standpipe may be required to be converted to a temporary dry standpipe with an air pressurized alarm system.

The CSFSM should ensure that air pressurized alarm system is working properly by conducting daily visual inspection of the gauges on the system and performing spot checks on portions of the standpipe system. Tracing of the standpipe riser(s) may be necessary if the alarm is activated.

The following provisions shall apply to the air pressurized alarm system:

(1) Pressure

Pressure shall be maintained in the standpipe and cross connections at all times and shall not exceed 25 psig by utilizing nitrogen or an air compressor with an air dryer. The supervisory pressure shall be as determined by a registered design professional. The daily visual inspection should include checking if the gauges showing the correct pressure.

(2) Automatic Air Pressurized Alarm Activation

The alarm shall be automatically activated when the pressure drops below the supervisory pressure or rises above the maximum pressure of 25 psig.

When the alarm is activated, notification shall be made to the Fire Department (refer to Chapter 17 of this booklet), all work at the site shall cease and an investigation of the entire standpipe system and air compressor shall be immediately performed to determine the cause of the alarm. Unless authorized by the Fire Department, no construction or demolition work shall resume until the standpipe system is repaired and the appropriate pressure is restored, except that any repairs to the standpipe system needed to restore the required pressure shall be undertaken immediately and the standpipe system restored as soon as possible.

There shall be compliance with the requirements of the New York City Fire Code while the standpipe system is out of service. Upon completion of repairs to the standpipe system a full inspection of such system shall be performed, which shall include, among other things, visually tracing the standpipe, including risers, cross connections and fire department connections to verify that no breach exists and checking all gauges of the standpipe system to ensure the standpipe system has been restored to a state of readiness.

Exception

The activation of the alarm shall not require the cessation of work necessary for the completion of concrete pouring operations in progress at the time of alarm activation, where such cessation would cause a cold joint that would impair the structural integrity of the finished construction. The continuation of such operations shall be permitted only until an orderly termination of such operations can be effectuated. The site safety manager or coordinator shall record the names and locations of any employees necessary for the completion of the concrete pouring operations and provide them to the Fire Department personnel who arrive on the scene.

(3) Air compressor

The air compressor shall be designed to automatically cut in and cut out at the supervisory pressure and shall be tied into the standpipe system between the fire department connections and the house check valves. The air compressor shall utilize an air dryer during times when freezing conditions exist to condition the air entering the dry standpipe system. The daily visual inspection should include ensuring if the air compressor is in good working condition.

(4) Alarm

The standpipe alarm system shall utilize pressure switches and control equipment to annunciate a local audible alarm on site that can be heard during working and non-working hours. The audible signal of the horn shall be at least 15 dBA above the ambient noise level but no more than 110 dBA.



Figure 4-14. Standpipe alarm system

(5) Power Supply

The standpipe alarm system shall be connected to an active, dedicated power supply at all times. The daily visual inspection should include ensuring that the power supply is not interrupted or compromised.

(6) Check Valves

Check valves shall be installed to prevent water from entering the air compressor.

(7) Locks and caps

All control valves shall be chained and locked in the appropriate position and shall be provided with capped outlets. All hose valves shall also be provided with capped outlets. The daily visual inspection should ensure these requirements are met.

(8) Fire Department connections

Three-inch iron hose plugs with gaskets in Fire Department connection swivels shall be provided. The daily visual inspection should ensure the correct hose plugs are paced correctly.



Figure 4-15. Iron hose plugs

(7) Drainage

Provisions shall be made to drain water in any trapped sections of the dry standpipe system that are subject to freezing. The CSFSM should consider the weather condition to ensure this no freezing issues in the dry standpipe system. The recommended weekly testing should ensure that water is properly drained.

(8) Manual Air Release Connection

A minimum 2.5-inch connection located immediately downstream of the fire department connection check valve shall be provided and piped to a location immediately adjacent to the fire department connections. This line shall be fitted with a 2.5-inch hose valve and shall allow for release of the pressurized air from the dry standpipe system. The number of air release valves provided shall be such that the air pressure shall be released in no more than 3 minutes, which shall be verifiable by an actual air release test performed at the time of the initial installation.

(9) Construction Documents.

Plans shall identify all standpipe risers, cross connections, fire department connections, any intermediate check valves that have to be removed, proposed location of the air release connections, designation of the supervisory pressure, complete information regarding the alarm system, and procedures for the safe pressurization and depressurization of the system. These documents must be kept on the site and be readily available.

(10) Signage

Signage shall be provided at all Fire Department connections indicating that the dry standpipe system is pressurized and showing the location of the manual air release.





Figure 4-16. Signages

(11) Pressure Gauges

A system of pressure gauges shall be installed at the compressor and at the most remote points of the system from the compressor. The daily visual inspection should ensure the pressure gauges are in good working order and not compromised.



Figure 4-17. Examples of a Standpipe Compressor/Alarm Configuration

#### 4.2.6 Standpipe System Inspections, Maintenance and Testing

*1. Initial Testing:*

The required standpipe systems must be tested by a licensed plumber or a fire suppression contractor upon installation.

*2. Building Department Inspection:*

Building Department inspections are required at various stages of completion, as well as at the final completion of standpipe systems.

The Standpipe Enforcement Unit of Building Department conducts a random audit of all self-certified notices to ensure compliance of inspected work with Building Code and regulations.

Based on the project scope of work, the following sprinkler inspections may be required:

**Underground Piping.** Bedding, pitch, materials, protection, flushing

**Roughing Work.** Piping, valves, components, size, location, materials, hangers

**Test.** Hydrostatic, flow, Dry Pipe Valve, Fire Pump, and controls - Painting: where the project work requires a hydrostatic pressure test, all painting shall be completed prior to such test

**Finishes.** Painting, escutcheons, signage, labeling, chaining of valves, and central station

**Final Inspection and Sign-off.\*** Must be performed at the completion of all work and the system is active. Contractor must check for submission of all Special Inspection reports prior to completing a Final Inspection for project's sign-off. (*\*Contractors have the option to self-certify standpipe inspections.*)

*3. Contractor Self-Certification of Plumbing Inspections:*

For standpipe work, Contractors have the option to either require a Building Department Inspection or submit a self-certification of the completed work.

*4. Weekly Air Pressurized Alarm System Testing for Dry Standpipe Systems:*

The FDNY recommends that the Air pressurized standpipe alarm system should be tested each week to verify that the alarm and compressor are functioning properly. The General Contractor must ensure the test is only performed by a well-trained and knowledgeable person in testing the alarm system.

*The recommended procedures to perform the weekly Air Pressurized Alarm System Testing for Dry Standpipe Systems:*

*The system should not exceed a 25 psig. If it reads ~ 15 psi the compressor should start up, ~ 10 psi the alarm should sound. The procedure for the weekly test is listed in order below:*

- 1. Notify the FDNY dispatcher and communicate throughout site that a standpipe test will be performed;*
- 2. If the alarm system is connected to central station, the notification should be made to the central station before conducting the test;*
- 3. Go to a standpipe hose outlet and remove the outlet cap;*
- 4. Open the hose valve and release air pressure from the pressurized standpipe;*
- 5. Verify that the gauge on the compressor/standpipe to fall below alarm level. (~ 10 psi);*
- 6. Confirm the alarm is at the pre-set level;*
- 7. When the alarm sounds close the standpipe hose outlet valve;*
- 8. Verify the pressure builds back up to the sustained level (~ 25 psi);*
- 9. Notify the FDNY dispatcher, the construction site staff that the test has been concluded. (The central station should be notified too, if applicable)*
- 10. Enter the following in the standpipe log:*
  - Level alarm sounds;*
  - Level compressor starts up;*
  - Level Pressure sustains;*
  - Confirmation that alarm was heard by guard at main gate.*

5. Summary of inspection, maintenance and testing frequency:

Standpipe system and Air Pressurized Alarm System Inspection, Maintenance and Testing	Frequency
Licensed plumber/fire suppression contractor perform air/water test of standpipe.	During alarm install
Standpipe alarm installation documented by CSFSM.	During alarm install
Standpipe, including piping leading to Fire Department Connection, inspected visually on daily basis by CSFSM.	Daily
Construction drawings used to confirm routing of unexposed standpipe sections.	Daily
<i>Visually inspect if the components of air pressurized alarm system are in a good working order as indicated in section 4.5.5 of this booklet.</i>	<i>Daily</i>
FDNY/CSFSM Daily Reports must be kept by CSFSM documenting standpipe inspections, fire extinguisher inspections, and upkeep of permit logs.	Daily
<i>Standpipe, pressurizing system, and alarm tested weekly (Best practice).</i>	<i>Weekly</i>
Standpipe maintained under pressure and equipped with low pressure alarm.	Maintained As Needed
Standpipe alarm soundings logged and documentation includes description of response to alarm.	Per incident
Standpipe repaired and retested until retesting is successful after failed bi-weekly test by licensed plumber/fire suppression subcontractor. Repairs documented.	After failed biweekly inspection

4.3 Sprinkler System



Figure 4-18. Sprinkler systems

Sprinkler systems for use at construction sites must be provided, maintained, and made available for Fire Department use.

In buildings or structures where a sprinkler system is required by this code or the construction codes, including the Building Code, it shall be unlawful to occupy any portion of a building or structure until the sprinkler system installation has been tested and approved.

Sprinkler control valves shall be operated only by authorized personnel (e.g. Licensed Master Plumbers or the Licensed Master Fire Suppression Piping Contractor). Such operation shall be under the general supervision of the CSFSM. The CSFSM must know the status of the control valve. When the sprinkler system valves are being regularly closed and opened to facilitate connection of newly completed or disconnected segments, the sprinkler control valves shall be inspected at the end of each work day to ascertain that the system is in good working order.

*1. Alteration in a Building*

Existing sprinkler systems in buildings undergoing an alteration or demolition shall comply with the requirements of Sections 3303.7.4.1 through 3303.7.4.3.

Existing sprinkler systems in buildings undergoing an alteration shall be maintained in accordance with this following requirement:

Required means of egress, existing structural elements, fire protection devices, and sanitary (e.g maintain the hygiene) safeguards shall be maintained at all times during construction or demolition operations in existing buildings. Required means of egress shall not be obstructed in any manner that would destroy the full effectiveness of such means of egress.

Exception: Where adequate alternate provisions are provided in accordance with the requirements of the Building Code, or where the element is temporarily or permanently disconnected, removed, or demolished in accordance with the requirements of the Building code and of the agency or authority having jurisdiction to temporarily or permanently disconnect, remove, or demolish such element. Such alternative means, disconnection, removal, or demolition shall be shown on the approved plans. Fire protection systems, including but not limited to sprinklers, standpipes, and fire alarms, shall only be taken out of service in accordance with the requirements of the New York City Fire Code.

The red paint required by the NYC Building code must be maintained during any alteration operation.

Cross connections and risers for independent (stand-alone) existing sprinkler systems that are exposed during alterations shall be painted red and the handles of valves serving such existing sprinkler systems shall be painted green. Where the alteration requires a hydrostatic pressure test such painting shall be completed prior to such test.

**Exception:** Where a standpipe system is used as a combination standpipe and sprinkler system, the sprinkler risers and cross connections that are also used for the standpipe system shall be painted red and the handles of valves serving such combination system shall be painted yellow.

### 2. Buildings Undergoing Full or Partial Demolition

When existing sprinkler systems with Fire Department hose connections are present in buildings undergoing full or partial demolition, such systems must be maintained as a non-automatic sprinkler system, unless the sprinklers are damaged. When demolition starts, the sprinkler risers shall be capped immediately below the floor being demolished so as to maintain the sprinkler system on all lower floors for Fire Department use. Cutting and capping of sprinklers during demolition work shall be performed only by a Licensed Master Plumber or Licensed Master Fire Suppression Piping Contractor who has obtained a permit for such work. Fire department hose connections shall be kept free from obstruction and shall be marked by a metal sign reading "Sprinkler Connection" and by a red light at night. The FDNY recommends that the illumination should be maintained 24 hours everyday. The red paint shall be maintained during any demolition operations.

### 3. Removal of Damaged Sprinklers

Requests for a variance if you need to remove a damaged or inoperable sprinkler system or a portion of such system in connection with demolitions or gut rehabilitations. Applications for construction document approvals for such requests shall be filed with the Building Department by a registered design professional in accordance with the following procedure:

1. The filed application shall include a complete report prepared by the professional describing the extent of the damage and attesting as to why the system cannot be restored; and
2. The variance shall not be approved by the Building Department without the concurrence of the Fire Department as follows:
  - The applicant shall file the request for variance with the Fire Department;
  - The Fire Department shall review and recommend any necessary safety measures required as a condition of granting the variance; and
  - The applicant shall submit the Fire Department's recommendation to the department along with proof of satisfactory implementation of such safety measures.

## **4.4 Out-of-service fire protection systems**

"Out of service" means that the system is not in working order, either because it unexpectedly malfunctions and/or because it is being temporarily removed from service for repair, maintenance or construction. Fire protection system must first be operational ("installed and approved") before it can be "out of service." An Impairment Coordinator or fire watch is not required before system is installed and approved.

An Impairment Coordinator is required as soon as the fire protection system is “installed and approved”. “Installed and approved” means that all required approvals for a full or partial installation have been obtained, including all signoffs from the Department of Buildings.

The building owner shall designate an Impairment Coordinator to take the required actions when a standpipe system, sprinkler system or fire alarm system is out of service. **In most cases, the CSFSM will be designated as an Impairment Coordinator. Or the CSFSM must ensure such persons are designated and the CSFSM must monitor the performance of their duties.**

The Impairment Coordinator must maintain records of all system inspections, tests, servicing and other items of maintenance to be kept on the premises or other approved location for a minimum of 3 years and made available for inspection by any member of the FDNY.

When the CSFSM observes a minor defect not affecting the functionality of the fire protection system, he or she must also report the defect or condition to the owner.

#### 4.4.1 Fire watch

A fire watch must be maintained when a standpipe system, sprinkler system, or fire alarm system is out of service. Such fire watch must be conducted in compliance with the requirements as listed below:

- continuously patrol the area affected by the out-of-service fire protection system to which such person has been assigned, keeping constant watch for hazardous conditions;
- be provided with at least one approved means for notification of the Fire Department and the CSFSM on the premises (e.g. Notifying the FDNY by phone is the most direct and effective way to make notification of an emergency. If a wireless phone is used, it is important to be sure that the battery has enough power to last the entire shift.);
- immediately report any fire or smoke to the Fire Department and notify emergency preparedness staff on the premises;
- be trained in the use of portable fire extinguishers and equipped with a portable fire extinguisher, or made aware of the location of readily accessible portable fire extinguishers in the area to which such person has been assigned to maintain a fire watch;
- if safe to do so, be responsible for extinguishing fires when they are limited in size and spread such that they can readily be extinguished using a portable fire extinguisher;
- maintain a record of such fire watch on the premises during the fire watch and for a minimum of 48 hours after the fire watch has concluded (the CSFSM is responsible to maintain the record); and
- have no other duties during the fire watch.

#### 4.4.2 Fire guard

The fire watch required for an out-of-service standpipe system, sprinkler system, or fire alarm system must be maintained by one or more fire guards.

For the initial 4 hours of an unplanned and planned out-of-service condition when the affected area does not exceed 50,000 square feet, the Impairment Coordinator or a trained and knowledgeable person who is capable of performing fire watch duties and is designated by the building owner may perform the duties of the fire watch.

In other words, the Impairment Coordinator or a trained and knowledgeable person designated by the building owner should immediately begin conducting a fire watch in the area where the fire protection systems are out of service. However, an on-duty CSFSM is not allowed to perform fire watch since the fire watch personnel must have no other duties during the fire watch patrol. **After 4 hours of an out of service condition, such patrols must only be conducted by fire guards holding the F-01 Certificate of Fitness** (After 4 hours of the impairment, the S-60 or F-60 Certificate of Fitness holders are not authorized to be the impairment fire guards).

The number of fire guards generally depends on the location and the size of the area affected by the out-of-service fire protection system. A fire guard should be available to patrol all areas in which the fire protection system is out of service at least once every hour. No individual fire guard should patrol more than 50,000 square feet of building floor area. (How big is 50,000 square feet: A playing portion (without end zones) of a football field is roughly 57,000 square feet.) To meet this standard, it may be necessary that more than one fire guard be designated.

The required coverage for performing fire watch in affected area(s) is summarized below.

Area	Planned or Unplanned	
	The initial 4 hours	> 4 hours
≤ 50,000 ft <sup>2</sup>	An F-01C of F holder or an Impairment Coordinator or a trained and knowledgeable person	One F-01 C of F holder
> 50,000 ft <sup>2</sup>	One F-01 C of F holder for each 50,000 square feet	

The fire guard must be maintained continuously, 24 hours a day, until such systems are restored to good working order. In some cases, Fire Department personnel may be on scene and provide additional direction on the number of required fire guards or other fire protection measures that may be required until such time as the fire protection system is restored to good working order.



The fire guard for impairment should be familiar with the types of Pre-Fire Plans for the construction sites where they provide fire watch and the associated staff available to implement the plan. The fire guard must be familiar of his or her obligations to notify the Fire Department in the event of fire.

Fire guards must have a method of communicating to the emergency services. Fire guards can use cell phones to make immediate notifications. Fire guards should ensure that the cell phone is fully charged to cover the shift. Notifying by phone is the most direct and effective way to notify the Fire Department.

### **Fire Watch vs F-01/F-60 Fire Guard.**

**FIRE GUARD.** A person holding a certificate of fitness for such purpose, who is trained in and responsible for maintaining a fire watch.

**FIRE WATCH.** A temporary measure intended to ensure continuous and systematic surveillance of a building or portion thereof by one or more qualified individuals for the purposes of identifying and controlling fire hazards, including detecting early signs of fire, raising an alarm of fire, notifying the department, and performing such other fire safety duties as may be prescribed by the Fire Code. In summary, fire watch is a course of action taken to prevent fire and fire guard is someone who holds a Certificate of Fitness. When required by the Fire Code or Fire Rule, fire watch must be performed by a fire guard. But sometimes (e.g. the first 4 hours impairment situation and the area is less than 50,000 square feet) fire watch may be performed by a trained and responsible person.

#### 4.4.3 Planned Removal from Service.

The Impairment Coordinator must be made aware in advance of any planned removal from service of a standpipe system, sprinkler system, or fire alarm system, or system component, for repair, servicing, alteration, testing and other maintenance of the system or component or to allow construction to be performed in the area protected by the system without unnecessarily activating it. The Impairment Coordinator must authorize and personally supervise the placing of the fire protection system out of service.

Whenever the standpipe system is to be placed out of service for the addition of a new section to the system, removal of an existing section as demolition operations progress, or other planned event, the standpipe alarm may be temporarily deactivated subject to compliance with the requirements of the New York City Fire Code. All alarm activations, inspections, and repairs shall be logged into the logbook maintained by the CSFSM. If the standpipe system is **not returned to a state of readiness and the alarm reactivated within 2 hours of such planned removal from service, all construction or demolition work at the site shall cease**, unless otherwise approved by the Fire Department. **Under no circumstance shall hot work be conducted on the construction site until such time as the standpipe system is restored to service and the standpipe alarm reactivated.** The Fire

Department will determine other measures to take and the circumstances under which normal work may continue or resume.

Before authorizing the placing of the fire protection out of service, the Impairment Coordinator must:

- notify the Certificate of Fitness holder responsible for supervising the maintenance of the standpipe system, sprinkler system, or fire alarm system.
- determine the extent and expected duration of the out-of-service condition.
- inspect the areas or buildings involved and assess the increased risks.
- make appropriate recommendations to the owner.
- notify the Fire Department, if required (refer to Section 4.5.5 of this booklet).
- notify the responsible person designated by the owner to issue hot work authorizations. (hot work operation may need to be ceased)
- notify the central station and insurance carrier, if applicable.
- notify the occupants in the affected areas if the duration of time the sprinkler system or fire alarm system will be out of service is estimated to be more than 30 minutes.
- place a disc at each Fire Department Connection and place a tag at standpipe and sprinkler system control valve and Fire Command Center (if applicable), indicating which fire protection system, or part thereof, is out of service.
- maintain the fire protection system in service until work is ready to begin.
- record out-of-service information and situation in the logbook.

*Planned removal from service of standpipe system and standpipe air pressurized alarm.*

Whenever the standpipe system is to be placed out of service for the addition of a new section to the system, removal of an existing section as demolition operations progress, or other planned event, the standpipe alarm maybe temporarily deactivated subject to compliance with the requirements of this section. Where a site safety manager or coordinator is required by the Building Code, all alarm activations, inspections, and repairs shall be logged into the log book maintained by such site safety manager or coordinator. If the standpipe system is not returned to a state of readiness and the alarm reactivated within 2 hours of such planned removal from service, all construction or demolition work at the site shall cease, unless otherwise approved by the Fire Department.

4.4.4 Unplanned out-of-service condition.

Any person, upon becoming aware of any condition, except a planned removal from service, rendering a standpipe system sprinkler system or fire alarm system, or part thereof, inoperable in whole or in part, must notify the owner and the Impairment Coordinator of such condition. The Impairment Coordinator must take the actions set forth in FC901.7.3 and 901.7.5 (e.g. Section 4.5.3 of this booklet) and such other actions as are necessary or appropriate to protect the occupants of the building and promptly restore the system to service.

#### 4.4.5 Required tag or signs

Systems that are out of service, both planned and unplanned, must be immediately identified by placing a tag/disc at each of the following locations: **Fire Department Connections, standpipe and sprinkler system control valves, Fire Command Center, indicating which fire protection system or part thereof, is out of service.**

The Impairment Coordinator shall authorize the placement of system(s) out of service that are planned to be shut down. The Impairment Coordinator shall notify the qualified Certificate of Fitness holder about the system(s) that is/are out of service.

A clearly visible tag alerts building occupants and the Fire Department that all or part of the water-based fire protection system is out of service. The tag should be weather resistant, plainly visible, and of sufficient size [typically 4 in. × 6 in.]. The tag should identify which system is impaired, the date and time impairment began, and the person responsible.

Different tag colors indicate the level of impairment or defect as follows:

<b>Tag color</b>	<b>Impairment condition</b>
Red	Full or partially impaired, owner and FDNY must be notified, must be fixed immediately (e.g. air pressure in pressure tanks is not correct; control valve is closed or inaccessible, Fire Department Connection is not accessible, piping is leaking, etc.)
Orange	Critical Deficiency, owner must be notified, must be corrected within 30 days or FDNY must be notified. (e.g. water level in tank is not correct; the temperature is less than 40 °F in the pump room; piping may be subject to freezing conditions; etc.)
Yellow	Non-critical deficiency, owner must be notified, must be corrected within 30 days or FDNY must be notified. (e.g. tank supporting structure is damaged; main control valve is not sealed/locked or supervised; identification sign of Fire Department Connection is missing, etc.)
Green	System fully operational

Only FDNY, Master Fire Suppression Contractor, or Master Plumber (as restricted) is authorized to place a tag on a standpipe and/or sprinkler system. For systems that are fully or partially out of service that are not equipped with Fire Department Connections, the appropriate tags shall be placed at the main control valve. FDNY is to be notified immediately.

An impairment disc should be placed on the Fire Department connection to alert responding fire fighters of an abnormal condition. For example, **a disc (white or blue) should be placed at all affected Fire Department Connections** to inform responding Fire Department units of the out of service condition (**blue disc indicates partial out-of-service condition; white disc indicate completely out-of-service condition**). The Impairment Coordinator/building owner must ensure placement of these discs by Master Fire Suppression Contractor (Class A or B), a Master Plumber (as restricted), or FDNY units. When the condition has been corrected, the disc(s) must be removed immediately.



Figure 4-19. FDNY connection discs

#### 4.4.6 Notification to the Fire Department.

The Fire Department must be notified that a standpipe system, sprinkler system, or fire alarm system is out of service, whether by reason of a planned removal from service or an unplanned out-of-service condition.

- Standpipe systems (including Air pressurized standpipe alarm system).

Notify the FDNY at least 24 hours prior to any planned removal of the standpipe system from service at construction sites.

Notification must be made to the Fire Department whenever a standpipe system is or will be out of service for any period of time.

- Sprinkler systems and fire alarm systems.

Notification that a sprinkler system or fire alarm system, or any part thereof, is or will be out of service must be made to the Fire Department under the following circumstances:

- The sprinkler system or fire alarm system is or will be out of service on more than one floor of a building; or
- With respect to a sprinkler system, the work or repairs cannot be completed and the system restored to service, within 8 hours of the time the system was placed or went out of service; or
- With respect to a fire alarm system, the work or repairs will require the fire alarm system to be out of service for more than 8 hours in any 24-hour period; or
- One or more other fire protection systems in the area in which a fire protection system is out of service are or will also be out of service at the same time.

- Reporting requirements. Notification of an out-of-service condition must be made by the Impairment Coordinator to the borough dispatcher of Fire Department at the applicable telephone number as below:

Manhattan	(212) 570-4300
Brooklyn	(718) 965-8300
Queens	(718) 476-6200
Bronx	(718) 430-0200
Staten Island	(718) 494-4296

In an existing or completed building with 5 or fewer contiguous floors, any planned impairment shall be made in advance by a Letter of Notification to

Fire Department of the City of New York  
Construction, Demolition and Abatement Unit  
9 Metrotech Center  
Brooklyn, NY 11201-3857

The notification shall indicate **the detailed scope of work, date and time and the duration of the disconnection**, and **temporary fire protection measures** to be provided in the affected area.

#### 4.4.7 Restoring systems to service.

When an out-of-service device, equipment or system is restored to service, the Impairment Coordinator shall:

1. conduct necessary inspections and tests to verify that the affected systems are operational.
2. notify the FDNY.
3. notify the owner, central station, insurance carrier, emergency preparedness staff, and, if previously notified, the occupants in the affected areas.
4. remove the out-of-service tags.

#### 4.4.8 Out-of-service standpipe systems at construction sites.

The owner, CSFSM and/or Impairment Coordinator shall take the following actions whenever a standpipe system at a construction site is out of service:

1. Immediately notify the FDNY of any unplanned out-of-service condition, and otherwise comply with the requirements of Section 4.5.4 of this booklet.
2. Notify the FDNY at least 24 hours prior to any planned removal of the standpipe system from service, and otherwise comply with the requirements of Section 4.5.3 of this booklet.
3. Ensure that a fire watch is continuously maintained in compliance with the requirements of Section 4.5.1 of the booklet while the standpipe system is out of service.
4. Planned removal from service of standpipe system and standpipe air pressurized alarm. Whenever the standpipe system is to be placed out of service for the addition of a new section to the system, removal of an existing section as demolition operations progress, or other planned event, the standpipe alarm

maybe temporarily deactivated subject to compliance with the requirements of this Section. All alarm activations inspections, and repairs shall be logged into the log book maintained by such site safety manager or coordinator.

4. Repair the standpipe system and return it to service in compliance with the requirements of Section 4.5.7 of this booklet and Section 3303.8.1 of the Building Code. The construction site may continue to be occupied, and construction, demolition or alteration activities may continue, pending such repair and restoration to service, except:
  - If the standpipe system is not returned to a state of readiness and the alarm reactivated within 2 hours of such planned removal from service, all construction or demolition work at the site shall cease, unless otherwise approved by the Fire Department; and/or
  - as otherwise directed by the commissioner upon a determination that, in the absence of an operable standpipe system, the conduct of certain construction, demolition or alteration activities would be imminently perilous to life or property; and
  - that in no circumstance shall hot work be conducted on the construction site until such time as the standpipe system is restored to service and the standpipe alarm reactivated.

## CHAPTER 5. PORTABLE FIRE EXTINGUISHERS

Portable fire extinguisher related violation is the most common violations that FDNY issue to the construction sites. The CSFSM must ensure that all fire extinguishers are provided at the required location with the FDNY standardized tags. During the daily inspection, the CSFSM should ensure that all fire extinguishers are readily accessible and fully functional for immediate use.

### 5.1 Location and Size

In general, the FDNY recommends that all extinguishers should be a minimum of 2:A 20:BC rated with maximum travel distance to any fire extinguisher not to exceed 75 ft. Provide one extinguisher for every 1,500 sq/ft.

Buildings or structures under construction, alteration or demolition shall be provided with not less than one approved portable fire extinguisher in accordance with Fire Code and sized for not less than ordinary hazard as follows:

1. At each stairway on all floor levels where combustible materials are being stored or combustible waste is being generated.
2. At the entrance of each storage and construction shed.
3. Additional portable fire extinguishers shall be provided where flammable and combustible liquids are stored, handled and used.

Flammable/combustible liquids with depths of less than or equal to 0.25 inch

Type of Hazard	Basic Minimum Extinguisher Rating	Maximum Travel Distance <sup>d</sup> to Extinguishers (feet)
Light (Low) <sup>a</sup>	5-B	30
	10-B	50
Ordinary (Moderate) <sup>b</sup>	10-B	30
	20-B	50
Extra (High) <sup>c</sup>	40-B	30
	80-B	50

- a. Light(low) hazard occupancies consist of fire hazards having normally expected quantities of Class A combustible furnishings, and/or the total quantity of Class B flammable typically expected to be present is less than 1 gal in any room or area.
- b. Ordinary(moderate) hazard occupancies consist of fire hazards having normally expected quantities of Class A combustible furnishings, and/or the total quantity of Class B flammable typically expected to be present is between 1 gal to 5 gal in any room or area.
- c. Extra(high) hazard occupancies consist of fire hazards having normally expected quantities of Class A combustible furnishings, and/or the total quantity of Class B flammable typically expected to be present is more than 5 gal in any room or area.
- d. The travel distance is intended to be the actual walking distance along a normal path of travel to the extinguisher.

4. Cranes fueled by liquid motor fuel or flammable gas shall be provided with a portable fire extinguisher with a minimum 10-B:C rating located either in the crane's cab or in its immediate vicinity.
5. Additional requirements for hot work operation
  - A minimum of one portable fire extinguisher complying with the requirements of Fire Code and with a minimum 2-A:20-B:C rating must be provided and readily accessible within a 30 feet travel distance of the location where hot work is performed and where the fire guards are positioned.
  - There shall be not less than one multi-purpose portable fire extinguisher with a minimum 3-A 40-B:C rating on the roof being covered or repaired.
6. Additional requirements for LPG related activities

A portable fire extinguisher with at least a 10-B:C rating is required at all locations where LPG/CNG is used, stored or transported.

Each construction site LPG storage enclosure shall be equipped with at least one 40-B/C rated, wheeled, fire extinguisher. Such fire extinguisher must be kept outside of the storage facility or placed at another readily accessible location not more than 30 feet from the storage facility.



Figure 5-1. Wheeled Fire Extinguisher

7. Additional requirements for space heaters
  - Portable space heaters fueled by piped natural gas at construction sites: A portable fire extinguisher with at least a 20-B:C rating shall be provided on each floor of the *construction site* at a location not more than 30 feet from where a heater is in use or connected for use. A travel distance of up to 50 feet is allowed if a portable fire extinguisher with at least a 40-B:C rating is provided.
  - Coke-fueled salamander: Areas in which coke-fueled salamanders are in use shall be provided with portable fire extinguishers with at least a 4-A rating for each 1000 square feet, with a maximum travel distance to an extinguisher of not more than 75 feet.
8. At least one portable fire extinguisher having a minimum 2-A rating shall be provided in the area where powder-actuated tool loads are stored.



9. *At least 1 at each area where wood scaffolding is erected at a height of 40 feet or greater\**

10. *At least 1 at each construction hoist landing\**

\*can be included into 1 per 1,500 square foot calculations.

Portable fire extinguishers shall be located in conspicuous locations where they will be readily accessible and immediately available for use. These locations shall be along normal paths of travel, unless the commissioner determines that the hazard posed indicates the need for placement away from normal paths of travel.

Portable fire extinguishers shall not be obstructed or obscured from view. In rooms or areas in which visual obstruction cannot be completely avoided, signs or other markings shall be provided to indicate the locations of portable fire extinguishers.

Cabinets used to house portable fire extinguishers shall be readily identifiable and shall not be locked.

## **5.2 Installation**

Hand-held portable fire extinguishers, not housed in cabinets, shall be installed on the hangers or brackets supplied. Hangers or brackets shall be securely anchored to the mounting surface in accordance with the manufacturer's installation instructions.

Portable fire extinguishers weighing 40 lbs. or less must be installed so that the top of the extinguisher is not more than 5 ft. above the floor. Hand-held portable fire extinguishers weighing more than 40 lbs. must be installed so that the top of the extinguisher is not more than 3.5 feet above the floor. The clearance between the bottom of the extinguisher and the floor must not be less than 4 inches. In other words, **no fire extinguisher is allowed to be on the floor.**

Wheeled portable fire extinguishers shall be kept in the designated location (e.g. LPG container storage area) that is readily accessible.

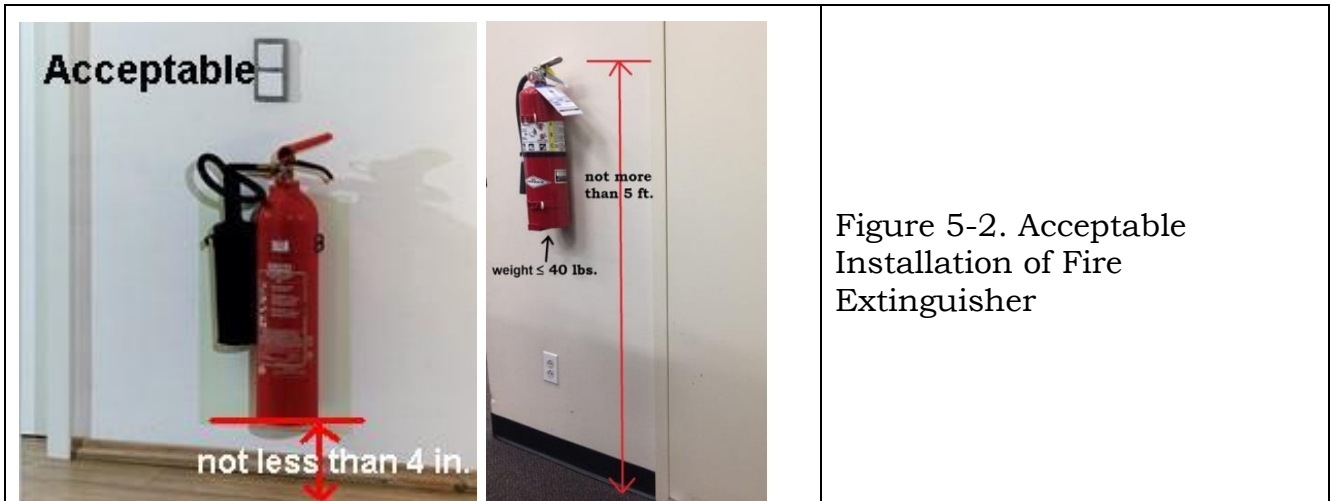

Figure 5-2. Acceptable Installation of Fire Extinguisher

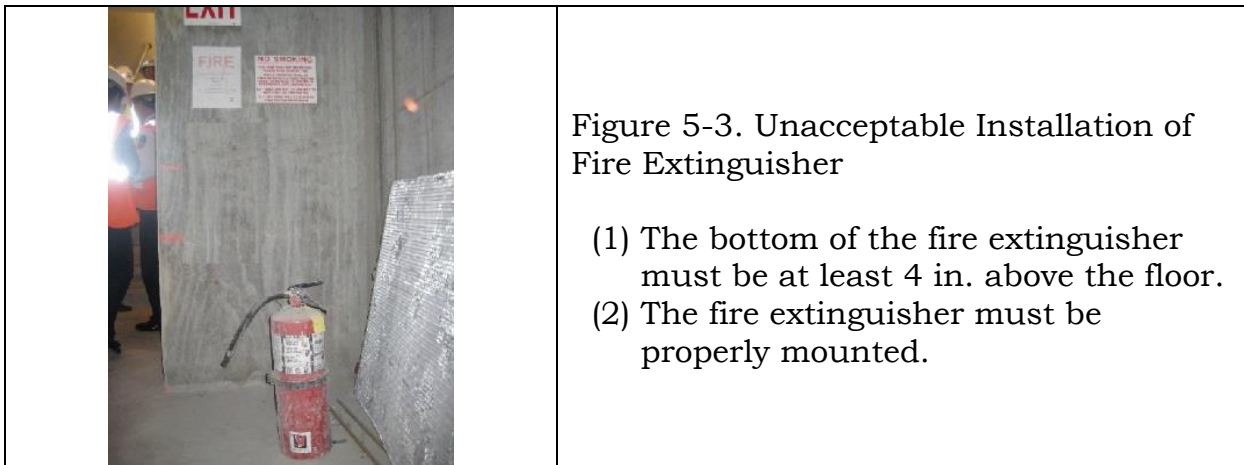

Figure 5-3. Unacceptable Installation of Fire Extinguisher

- (1) The bottom of the fire extinguisher must be at least 4 in. above the floor.
- (2) The fire extinguisher must be properly mounted.

### 5.3 Portable Fire Extinguishers Operation

CSFSM and construction site personnel must be familiar with the different types of portable fire extinguishers (PFE's). **All construction site personnel must know how to operate the extinguishers in a safe and efficient manner.** They must know the difference between the various types of extinguishers and when they should be used.

In the event that a fire extinguisher has been discharged, it must be fully recharged or replaced prior to being used again. Portable fire extinguishers are important in preventing a small fire from growing into a catastrophic fire; however, they are not intended to fight large or spreading fires. Portable fire extinguishers should only be used when there is an available means of egress that is clear of fire. By the time the fire has spread, fire extinguishers, even if used properly, will not be adequate to extinguish the fire. Such fires should be extinguished by the building fire extinguishing systems or **trained firefighters only.**

In case of any fire, 911 must be called. Fire extinguishers must be used in accordance with the instructions painted on the side of the extinguisher. They clearly describe how to use the extinguisher in case of an emergency. The CSFSM

should be familiar with the use of portable fire extinguishers. When it comes to using a fire-extinguisher, remembering the acronym **P.A.S.S.** help to make sure it is used properly. **P.A.S.S.** stands for **P**ull, **A**im, **S**queeze, **S**weep. The CSFSM must also train all construction site personnel and ensure they know how to use portable fire extinguishers.



Figure 5-4.  
A small-in-size fire that may be extinguished by a portable fire extinguisher

Figure 5-5. The fire has spread, portable fire extinguisher is NOT enough.

### 5.4 Different Types of Portable Fire Extinguishers

Fire extinguishers are classified by the type of fire that they will extinguish. Some fire extinguishers can only be used on certain types of fires, while other fire extinguishers are made to extinguish more than one type of fire. The portable fire extinguisher classification is indicated on the right side of the extinguisher. For more detailed information regarding the different portable fire extinguisher classifications and the types of fires they extinguish, reference the chart below.

Class of Fire	Type of Fire	Type of Extinguisher	Extinguisher Identification	Symbol
<b>A</b>	Ordinary combustibles: wood, paper, rubber, fabrics, and many plastics	Water, Dry Powder, Halon		
<b>B</b>	Flammable Liquids and Gases: gasoline, oils, paint, lacquer, and tar	Carbon Dioxide, Dry Powder, Halon		
<b>C</b>	Fires involving Live Electrical Equipment	Carbon Dioxide, Dry Powder, Halon		
<b>D</b>	Combustible Metals or Combustible Metal Alloys	Special Agents		No Picture Symbol 
<b>K</b>	Fires in Cooking Appliances that involve Combustible Cooking Media: Vegetable or Animal Oils and Fats			

Figure 5-6. Types of Extinguishers

The most commonly sold portable fire extinguishers are labeled ABC extinguishers. Class ABC extinguishers are often the primary portable fire extinguishers in offices, hotels, theaters, and classrooms. Class ABC extinguishers are dry chemical extinguishers that can be used to extinguish regular combustible fires, flammable liquid fires, and fires involving electrical equipment. ABC extinguishers are usually red in color and range in size from 5-20 lbs. The pictures below show an example of a Class ABC portable fire extinguisher.











Figure 5-7. ABC Fire Extinguisher Label

Class A portable fire extinguishers are available but are not as prevalent as Class ABC extinguishers. Class A portable fire extinguishers are also known as Air Pressurized Water (APW) fire extinguishers. Water is an extinguishing agent for regular combustibles.

These extinguishers are usually silver in color and approximately 3 feet in height and weight approximately 25 lbs. Class A portable fire extinguishers are useful in buildings and occupancies that primarily contain Type A combustible materials. These PFEs should ONLY be used on ordinary combustible fires. The picture to the right shows an example of a typical Class A portable fire extinguisher. Class A fire extinguishers are subject to freezing. They should not be used in situations where the extinguisher is subject to cold temperatures.

Portable fire extinguishers with a classification of “BC” are used to extinguish flammable liquid fires and electrical equipment fires. Portable fire extinguishers with a classification of just “B” or a classification of just “C” do not exist. “BC” portable fire extinguishers are red in color and range in size from five 5-100 lbs. or larger. Carbon Dioxide portable extinguisher is one common Class BC portable fire extinguishers. An example of a BC portable fire extinguisher is shown in the picture. As mentioned above, a portable fire extinguisher with just a “C” classification does not exist. The “C” classification indicates ONLY that the extinguishing agent is a nonconductor and is safe to use on live electrical fires. “C” fires will have either an “A” component, such as ordinary combustibles around the electrical item, or a “B” component such as an oil filled transformer or some electrical device involving flammable liquids. This is the reason “C” classifications are only attached to either a “B” or “AB” fire extinguisher. This classification specifies the fire extinguisher that is most appropriate for extinguishing the fire.

			Suitable for Class B and Class C fires but not Class A
			Suitable for Class A fires but not Class B or Class C
			Suitable for Class A and Class B fires but not Class C

Portable fire extinguishers are labeled so users can quickly identify the classes of fire on which the extinguisher will be effective. The marking system combines pictures of both recommended and unacceptable extinguisher types on a single identification label. The left chart is an example of typical labels.

## 5.5 Portable fire extinguisher tags, inspection and servicing

### 5.5.1 Portable fire extinguisher (PFE) tags

Installed portable fire extinguishers must have an FDNY standard PFE tag affixed. This tag will have important information about the extinguisher. By November 15, 2019, all portable fire extinguishers must have the new PFE tags. The FDNY will only recognize new PFE tags and will be issuing violations to business that have PFE installed without a proper tag.

The color of the fire extinguishers may be changed by the FDNY every few years. The FDNY recommends two ways to verify the tag’s legitimacy:

#### 1. Hologram:

A real hologram strip shown on the tag is 3 inches long by ¼ inch wide. Counterfeit tags will NOT have a high quality silver hologram. The hologram on a counterfeit tag will NOT change color as it is moved against the light.

#### 2. QR code

IF you scan the QR code, it should direct you to the updated FDNY approved fire extinguisher company list. You can use the company list to verify if the company printed on the list is currently approved by the FDNY.

If your PFE tags cannot be verified via these two methods, contact your supervisor. If you suspect your PFE is a counterfeit, contact FDNY immediately by e-mail:

[Tags.Decal@fdny.nyc.gov](mailto:Tags.Decal@fdny.nyc.gov)

**FRONT**

**DO NOT REMOVE  
BY ORDER OF THE FDNY**

• ABC (Dry Chem)	• HALOTRON
• AFFF/FFFP	• WATER
• BC (Dry Chem)	• LOADED STREAM
• PURPLE K (PK)	• WET CHEM
• CARBON DIOXIDE	• CLEAN AGENT
• CLASS D (Dry Powder)	• INTERGEN
• CLASS K	• WATER MIST
• FE-36	• FE-13
• FM 200	
• HALON 1211	
• HALON 1301	



THIS PORTABLE FIRE EXTINGUISHER HAS BEEN SERVICED  
AS REQUIRED BY NYC FIRE CODE 906.2.1.2

**2021**

**2022**

**2023**

PROOF OF COMPLIANCE FOR USE BY CERTIFIED  
PORTABLE FIRE EXTINGUISHER SERVICING COMPANY

VOID 1 YR. FROM MONTH PUNCHED											
SERVICED			NEW			RECHARGED					
JAN	FEB	MAR	APR	MAY	JUNE	JULY	AUG	SEPT	OCT	NOV	DEC

**BACK**

**DO NOT REMOVE  
BY ORDER OF THE FDNY**

Name

C of F

Company

DBA

NYC LIC#

Address

Phone Number

**MONTHLY INSPECTION RECORD**

DATE	BY	DATE	BY



**DON253W220004746**



PUBLIC USE: Scan to check company info

SERIAL #

PREMISES ADDRESS

UNAUTHORIZED POSTING IS A CRIME PUNISHABLE BY FINE AND/OR IMPRISONMENT

COF stamp

Hologram

QR code

Figure 5-8. PFE tag (This tag is released for 2021-2023)

Fire Department also issues standard outdoor fire extinguisher tags. If the fire extinguishers may be placed outdoors, the CSFSM should ask the fire extinguisher suppliers to provide the outdoor fire extinguisher tags for the fire extinguishers.

The special features of the outdoor tags:

1. The material is durable and tear-resistant
2. Different printings:
  - On the back of the tag, the series number will contain a “D” letter; AND/OR
  - On the front of the tag, an “O” is printed on the top of the tag (this feature may not be on ALL outdoor tags)



Figure 5-9. Outdoor PFE tags

### 5.5.2 Monthly Inspections

#### MONTHLY INSPECTION

The portable fire extinguishers are required to be checked monthly. The owner of the business is responsible to select a person to do a monthly inspection. This monthly inspection is called a "quick check".

The QUICK CHECK should check if:

- the fire extinguisher is fully charged;
- it is in its designated place;
- it has not been actuated or tampered with;
- there is no obvious or physical damage or condition to prevent its operation.

The information of the monthly inspection record must include the date of the inspection, the name/initials of the person who did the inspection. This monthly quick check is documented on the back of the PFE tag or by an approved electronic method that provides a permanent record.



### 5.5.3 Portable fire extinguisher annual servicing

Servicing is a thorough examination of the portable fire extinguisher. It is intended to give maximum assurance that the portable fire extinguisher will operate effectively and safely. It also includes any necessary repair or replacement. Servicing the portable fire extinguisher will reveal if hydrostatic testing or internal maintenance is needed. Portable fire extinguishers must be serviced **at least annually** or at the time of hydrostatic testing, or when physical damage to the cylinder is visible during a monthly inspection. Portable fire extinguishers removed for servicing must be replaced by a similar PFE and must be of at least equal rating. The annual servicing must be performed by one of the FDNY approved companies for servicing portable fire extinguishers:

<http://www1.nyc.gov/assets/fdny/downloads/pdf/business/approved-companies-full-service-portable-fire-extinguisher.pdf>

**A W-96 Certificate of Fitness holder employed by an FDNY approved company is required to service, maintain, and/or recharge** a portable fire extinguisher. CSFSM are responsible for making arrangements to have all the extinguishers serviced by a qualified Certificate of Fitness holder (W-96) and by an FDNY approved company. After each annual inspection W-96 COF holder will replace the PFE tag. The information of the annual inspection record must be indicated on the new PFE tag.

An FDNY released fire extinguisher brochure is available on the following website:  
<http://www1.nyc.gov/assets/fdny/downloads/pdf/business/Support/portable-fire-extinguishers-in-your-business.pdf>



## **CHAPTER 6. PRECAUTIONS AGAINST FIRE**

### **6.1 Smoking Prohibited**

**Smoking is prohibited at all construction sites.** Everyone at construction site including visitors and delivery drivers must abide by no-smoking regulations. Tobacco products and smoking paraphernalia are also banned on asbestos and abatement sites. Smoking, including the carrying of a lighted pipe, cigar, cigarette or any other type of smoking paraphernalia or material (e.g. e-cigarettes or vaping) is prohibited at all construction sites.

Smoking is **not** permitted at any construction site or buildings undergoing construction or demolition, trailers and other indoor or outdoor areas that enclosed by a fence.

Smoking is also **not** permitted at any area in existing buildings undergoing interior alterations where NYC Department of Building permits are issued.

The Smoke Free Air Act (SFAA) prohibits smoking and the use of electronic cigarettes in most workplaces and public spaces. This includes areas near hospital entrances, in parks, beaches and pedestrian plazas.

Smoking is also prohibited:

- within 15 feet of any entrance or exit to a health care facility;
- within 100 feet of entrances, exits or outdoor areas of public libraries, public or private elementary or secondary schools.

#### **6.1.1 No Smoking Signs**

Missing smoking sign is one of the most common violations that the construction sites may receive. The CSFSM should ensure the no smoking signs comply with the FDNY regulations.

Durable “No Smoking” signs shall be conspicuously posted at construction sites at the following locations and such other locations as are necessary to provide notice to a person entering upon or working at the site of the prohibition against smoking:

1. at construction sites required by the Building Code to be enclosed with a fence, on all sliding and swinging gate openings, and any other openings allowing for access to the site by persons or vehicles;
2. at the entrances to any building or structure under construction or demolition;
3. on each floor at stairway, elevator and hoistway access points of any building undergoing alteration, construction or demolition; and
4. at any indoor or outdoor areas on the construction site at which persons congregate.

The signs must be provided in English as a primary language. A posted “No Smoking” sign must not be removed, obscured, or rendered illegible.

The Fire Department has published an approved “No Smoking” sign. It is set forth in Fire Department rule (see figure). However, the Fire Department does not mandate that this design be used. Other legible, durable signs, clearly communicating the “no smoking” requirement, may be used but are subject to Fire Department enforcement action if found to be inadequate.

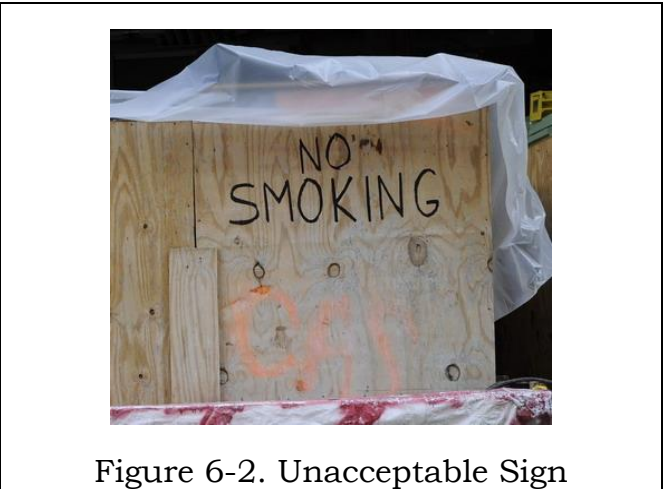

## 6.2 Open Fire, Waste Disposal and Housekeeping

It shall be unlawful to ignite or maintain an open fire at a construction site, except for the use of coke-fueled salamanders. If the Construction Site has a Fire Department permit to use a coal-fired heater, the CSFSM must minimize the fire load on concrete construction projects.

Combustible waste, including rubbish and construction and demolition material, shall not be allowed to accumulate within buildings and shall be removed from a building at least once a day.

Rubbish and other combustible waste stored pending removal in a building or structure or upon a premises shall be stored in accordance with applicable law, rule or regulation:

- **Spontaneous ignition.** Rubbish and other combustible waste susceptible to spontaneous ignition, such as oily rags, shall be stored in a listed disposal container. Contents of such containers shall be removed and disposed of daily.



<ul style="list-style-type: none"><li>• <b>Capacity exceeding 40 gallons.</b> Dumpsters and other containers with a capacity exceeding 40 gallons shall be provided with lids. Such containers and their lids shall be constructed of noncombustible materials or of materials having a peak rate of heat release not exceeding 300 kW/m<sup>2</sup> when tested in accordance with ASTM E 1354 at an incident heat flux of 50 kW/m<sup>2</sup> in the horizontal orientation, and listed and labeled as such.</li></ul>	 <p>Figure 6-4. Small dumpster</p>
<ul style="list-style-type: none"><li>• <b>Capacity exceeding 200 gallons.</b> Dumpsters and other containers with an individual capacity exceeding 200 gallons shall not be stored indoors, and shall not be stored outdoors within 5 feet of combustible walls, openings or combustible roof eave lines. (Note: 1 cubic yard = 202 gallons)</li></ul> <p><b>Exceptions:</b></p> <ol style="list-style-type: none"><li>1. Dumpsters or containers in areas protected throughout by a sprinkler system.</li><li>2. Storage in a building or structure of Type I or Type IIA construction or other construction with an equivalent fire rating, where such building or structure is located not less than 10 feet from other buildings or structures and used exclusively for container or dumpster storage.</li></ol>	 <p>Figure 6-5. Dumpster</p>

Sufficient containers, including but not limited to waste dumpsters, debris boxes, and skip boxes, shall be available for the storage of all debris or waste. Such containers shall be made of metal, plastic, or other non-combustible material acceptable to the Building Department. Such containers shall also comply with the following:

1. Containers with wheels shall be secured at the end of the workday by rope, cable, or chocking at the wheels in order to prevent movement.
2. Containers shall not be placed at the edge of the building at any time, except when being moved from the floor or building.
3. Containers holding debris or waste shall be covered at the end of the workday and at any time when full to near the rim. Containers need not be covered when they are not in use or while stored in a fully enclosed space at the end of the workday.

Control of debris shall include the following measures:

1. All floors, roofs, and working decks shall be cleaned of debris at least daily, and a daily inspection made by a competent person to verify such has occurred. If the building is a major building, such inspection shall be noted in the site safety log.
2. Debris that cannot be removed from the site by the end of the shift shall be placed in containers meeting the requirements of this section or shall be secured overnight to protect the public and property and shall be removed from the site or placed in containers at the beginning of the next shift.

Exception: Combustible debris shall not be permitted to accumulate and shall be removed from the site.

Accumulations of combustible waste not stored in containers in accordance with FC304.3 and in a manner that obstructs movement on the floor, or containing flammable or combustible liquid residues, shall be removed from a building at the end of each work shift.

Chute construction shall comply with BC 3303.5.5.

Combustible waste, including rubbish and construction and demolition material, shall be removed from the premises or stored in noncombustible containers.

Any hazardous materials brought on site must be accompanied by Safety Data Sheet (SDS). All SDS's shall be reviewed for flammability ratings. And materials must be provided with proper storage requirements.

### **6.3 Contractors sheds and offices (aka. Shanties)**

Contractors sheds and offices located within 30 feet of new construction, existing buildings, or another contractor shed or office shall be made of metal or other noncombustible material.

Exception:

Contractor sheds and offices located within a building and protected from weather may use fire retardant treated wood, provided the shed does not exceed one story in height and 120 square feet in area and is at least 30 feet from another shed.

#### ***Contractors Sheds and Offices Guidelines (Best Practice)***

- *Nighttime watchperson will be required to patrol all areas where a construction shed is located during all off work hours.*
- *The CSFSM is to review shed on a weekly basis recording the date of the review on the weekly log.*
- *Contractors using construction sheds shall maintain them free of accumulated trash/debris.*
- *All contractor sheds are to be free of newspapers on floor, windows, walls, etc.*

- *Contractors sheds construction should be made of sheet metal, tin or sheetrock. Knock down sheds may be used if constructed weekly with fire rated plywood wrapped in metal.*
- *Electric heaters are only permitted if it is mounted at the ceiling and installed by an electrician who follows Electrical Code.*
- *Oil filled heaters are only permitted to be used as a floor placed unit.*
- *Disconnect for contractors shed electrical service shall be clearly labeled for emergency purposes.*
- *ABC horizontal mounted extinguishing systems or tank shall be located in each shed. A sign must be located at the entrance to the shed that the ABC extinguisher is installed. This signage is for FDNY notification.*



Figure 6-6. Examples of construction shed with sheet metal protection

#### **6.4 Means of Egress and Elevators**

Stairways and elevators at construction sites shall be provided, maintained, and made available for department use in accordance with the construction codes, including the Building Code. Stairways providing egress from the building or structure under construction or alteration, and other components of the means of egress, shall be given construction priority.

Required means of egress shall be maintained during construction, alteration and demolition.

Exit signs in accordance with the NYC Building Code, including BC1011. The letter of exit signs must be red. The height of letters must be not less than 6 inches. Graphics must have letter widths, strokes and spacing in proportion to their height.



Figure 6-7. Acceptable Sign



Figure 6-8. Unacceptable Sign

## **6.5 Electrical**

Temporary wiring for electrical power and lighting installations at construction sites shall comply with the requirements of the Electrical Code and must be performed by the individual with a proper license.

Electrical service distribution panels, spark-producing operations, or open flames will be prohibited in areas used for fueling, transfer of fuel, or fuel storage areas.

Faulty temporary electrical systems can be a major source of fire at construction and demolitions projects.

The CSFSM should ensure the temporary electrical system does not present a fire risk by protecting electrical connections from exposure to moisture caused by day-to-day conditions at the site. Moisture can be a ready electrical conductor creating the potential for fires through arcing, short circuits, and overheating of electrical equipment. Common places for such problems to occur include:

- Broken or damaged electrical cords and cable, especially where such appliances are exposed to rain or standing water.
- Electrical boxes that are not sealed and allow for moisture intrusion.
- Use of improperly rated electrical equipment, such as lights or tools, in wet or damp locations.
- Electrical cords running along floors

During daily inspection, if the CSFSM is aware of any electrician's problem, the CSFSM must ensure this problem is fixed immediately by the individual with proper license (e.g. NYC Licensed Master Electrician).

## **6.6 Fire-Resistance-Rated Construction**

Fire walls, fire barriers, and spray-on fire protection of structural members required by the Building Code for the completed building, shall be given construction priority. Required fire doors, with automatic closing devices, shall be installed on openings as soon as practicable. Required fire walls, fire barriers and fire doors shall be left in place in buildings undergoing alteration or demolition until construction operations necessitate their removal.

## **6.7 Watchperson While Construction Operation is not In Progress**

At least one S-60 Watchperson is required at any construction site having a footprint of between 5,000 square feet and 40,000 square feet. The S-60 Certificate of Fitness is only valid provided the C of F holder maintains a current New York State security license.

**This competent watchperson must be on duty at the site during all hours when operations are not in progress.** The requirement starts from the time when the

foundation is poured to when all work has concluded and the certificate of occupancy or temporary certificate of occupancy has been issued.

Where the building has a footprint of more than 40,000 square feet, at least one additional S-60 watchperson must be on duty for each additional 40,000 square feet of building footprint, or fraction thereof.

Exceptions:

1. Where the construction site requires two or more watchpersons, the number of watchpersons may be reduced, subject to the approval of the commissioner, where:

- 1.1 An alarm or video monitoring system is in place, or where the layout of the building allows a continuous line of sight across the entire building; and
- 1.2 At least one watchperson is provided.

2. The building is being actively monitored in accordance with a fire safety and evacuation plan approved by the Fire Department in accordance with the New York City Fire Code.

In general, the watchperson should be aware of any activity happening at or around the construction site. The watchperson should remain alert to watch for abnormal activity or hear any unusual sounds. Moreover, the watchperson should be concerned about any activity that looks suspicious.

The watchperson must work in a responsible manner and should not be under the influence of intoxicating beverages, narcotics, controlled substances, and prescription or nonprescription drugs that can impair judgment.

The watchperson must be familiar with emergency notification procedures. All construction sites must have an emergency telephone that does not require a coin to operate. The construction site street address must be posted next to the phone or the approved device. The watchperson must know the location of this phone and must have immediate access to it. The watchperson can also use a wireless phone to make emergency notifications. If a wireless phone is used, it is important to be sure that the battery has enough power to last the entire shift.

If a watchperson becomes aware of a fire or other emergency at a construction site he/she must immediately telephone 911 and report the emergency. There should be no delays in making such notification. The watchperson should also immediately notify the Construction Site Fire Safety Manager of the emergency, but **only after telephoning 911.**

The CSFSM should ensure that the watchperson is familiar with the most updated Pre-Fire Plan, so the watchperson is capable to provide the required information to the first responders upon request.

## 6.8 Fire Watch and Fire Guard

The FDNY may require, at a demolition site, and at other construction sites that are unusually hazardous in nature, that a fire watch be maintained by fire guards. The fire guards conducting such fire watch should have a Certificate of Fitness and perform the duties and responsibilities as the F-01 fire guard such as:

- continuously patrol the affected area, keeping constant watch for fires;
- be provided with at least one approved means for notification of the department and the CSFSM;
- immediately report any fire to the department and notify emergency preparedness staff on the premises;
- be trained in the use of portable fire extinguishers and equipped with a portable fire extinguisher, or made aware of the location of readily accessible portable fire extinguishers in the area to which such person has been assigned to maintain a fire watch;
- be responsible for extinguishing fires when they are limited in size and spread such that they can readily be extinguished using a portable fire extinguisher;
- maintain a record of such fire watch on the premises during the fire watch and for a minimum of 48 hours after the fire watch has concluded (the CSFSM is responsible to ensure the fire guard making the record, and ensure the record is maintained on site; the CSFSM is also need to maintain the hot work authorization and the FDNY hot work permit); and
- have no other duties.

## 6.9 S-60, F-01 and F-60 Comparison

COF type	S-60	F-01	F-60
COF title	Watchperson at Construction Sites	Fire Guard for Impairment	Fire Guard for Hot Work Operations
When required	<ul style="list-style-type: none"> <li>• At least one S-60 Watchperson is required at any construction site having a footprint of between 5,000 square feet and 40,000 square feet; AND</li> <li>• During all hours when operations are not in progress.</li> </ul>	<ul style="list-style-type: none"> <li>• After 4 hours of an out of service condition, at least one F-01 COF holder must perform the fire watch at the affected area does not exceed 50,000 sqft;</li> <li>• If the area is more than 50,000 sqft, right after the out-of-service condition, one F-01 COF holder must be provided for each 50,000 sqft</li> </ul>	<ul style="list-style-type: none"> <li>• An F-60 COF holder must be provided for each torch operation at a construction site and in connection with torch-applied roofing system operations. (one per torch/tool)</li> </ul>
Duties	Refer to Section 6.7 of this booklet	Refer to Section 4.5.1 of this booklet	Refer to Section 7.2.4 of this booklet



## **CHAPTER 7. HOT WORK OPERATIONS**

Hot work operations and the equipment/materials associated with such operations represent a significant fire hazard. Hot work creates sparks, slag and heat. Materials such as acetylene, LPG, and oxygen are used in gas welding and torch operations. Electric current is used in arc welding. Hot work is often conducted in buildings that were not designed for these materials and hazards, including buildings undergoing renovation or repairs. An important factor in avoiding ignition hazards is preparing for and monitoring hot-work operations.

The Construction Site Fire Safety Manager shall be responsible for supervising the issuance of authorizations for hot work operations. The Construction Site Fire Safety Manager shall also ensure that any contractor that will be performing hot work have the appropriate FDNY permit (FDNY site specific permit or FDNY citywide permit). The Construction Site Fire Safety Manager must ensure that all personnel have the appropriate C of F prior to authorizing hot work operations.

The Construction Site Fire Safety Manager shall be responsible for supervising the issuance of authorizations for hot work operations. The Construction Site Fire Safety Manager shall also ensure that any contractor that will be performing hot work have the appropriate FDNY permit (FDNY site specific permit or FDNY citywide permit). The Construction Site Fire Safety Manager must ensure that all personnel have the appropriate C of F prior to authorizing hot work operations.

### **7.1 Permit and Certificate of Fitness**

#### **7.1.1 Certificate of Fitness**

- Certificate of Fitness (G-60) is needed for conducting any of the following torch operations:
  - An oxygen-fuel torch using any amount of oxygen and flammable gas
  - Any torch operation for torch-applied roof system
- Certificate of Fitness (F-60) holder must be present to perform fire watch during hot work operations at the following locations:
  - Construction sites;
  - Rooftop operations and in conjunction with torch-applied roof system operation;
  - In any building or structure when the torch operation is conducted by a person holding an FDNY permit for torch operation.

#### **7.1.2 Permit**

An FDNY permit is required to conduct hot work using oxygen and a flammable gas or using LPG/CNG gas only.

### 7.1.3 Hot work program responsible person

Whenever hot work is performed in any building or structure, on a building roof, or on a building setback, the owner must ensure that such work is performed in accordance with the Fire Code and must designate a responsible person (e.g. CSFSM) to ensure compliance.

The responsible person must ensure that a permit has been obtained from the Fire Department when one is required and ensure that the hot work is performed in compliance with the terms and conditions of the permit. The responsible person must inspect the hot work site prior to issuing a hot work program authorization and periodically monitor the work as it is being performed to ensure there are no fire safety hazards.

Hot work operations must be conducted under the general supervision of the responsible person. The responsible person must maintain “pre-work check” reports.

## **7.2 Operational requirements**

### 7.2.1 Authorized work areas

Hot work must be performed:

- in areas designated for hot work operations, or
- areas authorized by the responsible person.

Hot work must not be performed:

- in areas where the sprinkler protection is impaired.
- in areas where ignitable vapors are present.
- in areas where readily ignitable material is present.

Hot work operations involving cutting or welding must be conducted at least 35 feet from combustible materials and combustible waste or must be provided with appropriate shielding to prevent sparks, slag, or heat from igniting exposed combustibles. All other hot work operations must be conducted at least 25 feet from combustible materials and combustible waste or must be provided with appropriate shielding to prevent sparks, slag, or heat from igniting exposed combustibles.

### 7.2.2 Hot work program authorization (not the FDNY permit)

- A hot work program authorization bearing the signature of the responsible person must be obtained for any project conducted on a premises involving hot work operations by the person in charge of such hot work operations. Hot work authorizations, issued by the responsible person, must be available for inspection by any representative of the Fire Department during the performance of the work and for 48 hours after the work is complete.
- The hot work authorization must be readily available prior to commencing such work.

# HOT WORK AUTHORIZATION

- Note: This authorization applies only to this job, and in the area specified during the date and time noted.

GENERAL INFORMATION	
Hot Work Performed By: <input type="checkbox"/> Employee <input type="checkbox"/> Contractor   <input type="checkbox"/> Off-hours	Authorization #
Employee /	Contractors Name:
Supervisor / Foreman Name:	Supervisor / Foreman - On-site emergency contact phone number:
Location: Building address, room # and/or area of work . _____ _____	Start Date: _____ Permit Start Time: _____ Stop Date: _____ Permit Stop Time: _____ Comments: _____ _____

HOT WORK ACTIVITY				
<input type="checkbox"/> ARC WELDING	<input type="checkbox"/> SOLDERING	<input type="checkbox"/> GRINDING	<input type="checkbox"/> BRAZING	<input type="checkbox"/> USING OXYGEN AND A FLAMMABLE GAS (FDNY PERMIT)
<input type="checkbox"/> MAPP WELDING	<input type="checkbox"/> WELDING	<input type="checkbox"/> CUTTING	<input type="checkbox"/> NON-FIRE WORK	<input type="checkbox"/> OTHER: _____
<b><i>Torch operations using oxygen and a flammable gas, and any torch operation for torch-applied roofing systems, shall be performed by a certificate of fitness holder. Certificate holders shall be responsible for keeping such certificate upon his/her person or otherwise readily available for inspection.</i></b>				
Torch Operator:		Certificate #:	Exp Date:	
Fire Guard:		Certificate #:	Exp Date:	

ACCEPTANCE BY THE RESPONSIBLE PERSON FOR HOT WORK		
<b>I certify that all applicable codes, procedures, regulations, rules, pre-checks and safety precautions will be followed for as long as the hot work authorization is effective.</b>		
Name: _____ <input type="checkbox"/> Employee <input type="checkbox"/> Contractor	Signature: _____	Date: _____

DESIGNATED TO AUTHORIZE THE PERFORMANCE OF HOT WORK			
Name:	Signature:	Time:	Date:
Fire alarm precautions taken <input type="checkbox"/> YES <input type="checkbox"/> N/A Type: _____	Pre-hot work check completed: <input type="checkbox"/> YES FDNY permit required to conduct hot work? <input type="checkbox"/> YES <input type="checkbox"/> N/A		

- This authorization shall be available for inspection by any representative of the Fire Department during the performance of the work and for 48 hours after the work is complete.

### 7.2.3 Pre-hot work check

For hot work operation with citywide permit, the owner (or the responsible person designated by the owner) of the premises of the hot work operation areas **must** be notified in writing by the citywide permit holder **at least 48 hours before** the hot work is to be started.

For all hot work operations, the owner of the hot work operation areas must designate a responsible person (e.g. CSFSM). The responsible person must ensure that the hot work is performed in compliance with the terms and conditions of the permit. The person must inspect the hot work site prior to issuing the hot work authorization (hot work program authorization) to ensure that it is a fire safe area. He/she also need to periodically monitor the work as it is being performed to ensure there are no fire safety hazards. Hot work operations must be conducted under the general supervision of the responsible person.

Before hot work is authorized and at least once per day while the authorization is in effect, the hot work area shall be inspected by the responsible person to ensure that it is a fire safe area.

**The pre-hot work check must be conducted by the responsible person before hot work is authorized and at least once per day.** The check reports must be kept at the work site during the work, made available for inspection by a representative of the FDNY, and **maintained on the premises for a minimum of 48 hours after work is complete.**

**A pre-hot work check must be conducted at least once per day** and must verify the following:

1. The hot work equipment is in good working order.
2. The hot work area is clear of combustibles and flammable solids.

(1) 35 feet rule for cutting or welding operation

Hot work operations involving cutting or welding shall be conducted at least 35 feet from combustible materials and combustible waste or shall be provided with appropriate shielding to prevent sparks, slag or heat from igniting exposed combustibles.

(2) 25 feet rule for other hot work operation

All other hot work operations shall be conducted at least 25 feet from combustible materials and combustible waste or shall be provided with appropriate shielding to prevent sparks, slag or heat from igniting exposed combustibles.

The 2009 edition of National Fire Protection Association 51B shows the 35-ft. rule in a 3-D perspective. Detail information refer to Chapter 5 of NFPA 51B, 2009.

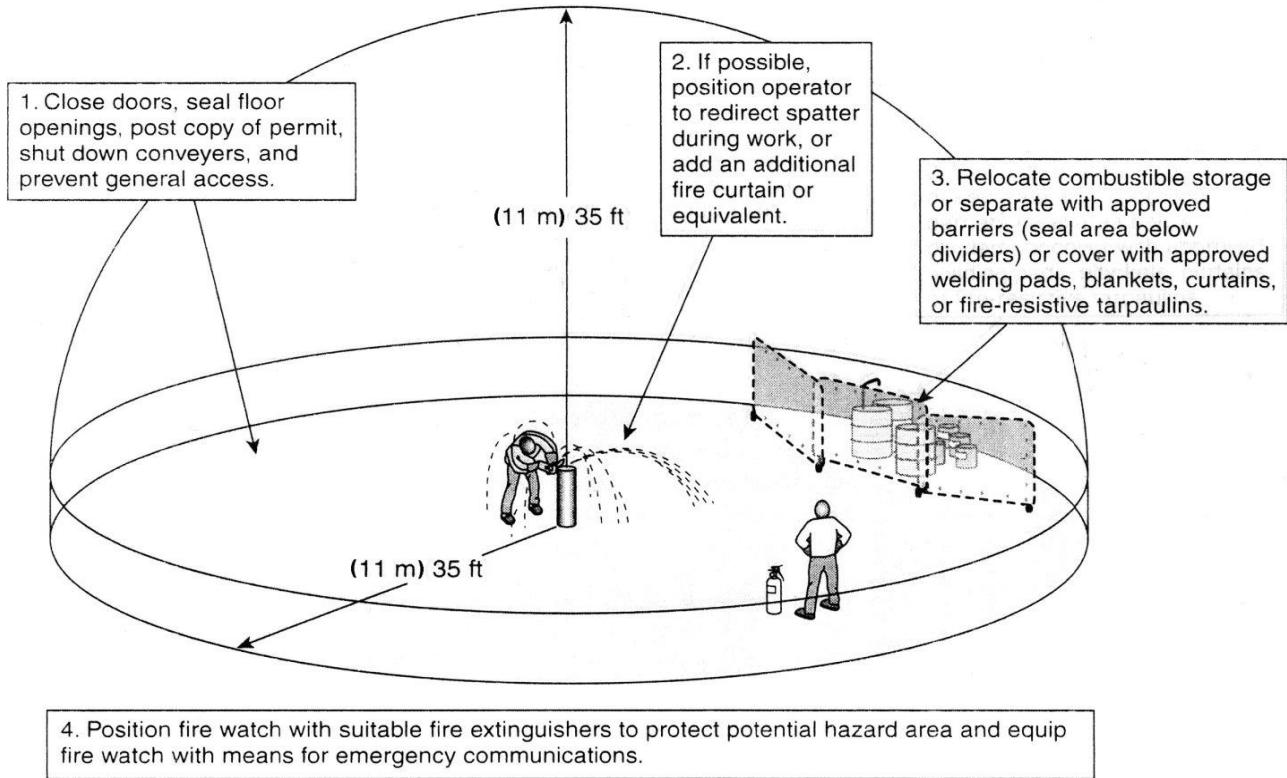

Figure 7-1. Hot work Area

3. Exposed construction is of noncombustible materials or, if combustible, is protected.

4. Openings are protected.

5. Hot work area floors are clear of combustible waste accumulation.

6. Fire watch personnel, where required, are assigned.

7. Approved actions have been taken to prevent accidental activation of fire extinguishing systems and detection equipment.

(1) if the sprinkler protection was installed and functional:

Sprinkler system protection **must not be shut off or impaired** while hot work is performed. Where hot work is performed close to sprinklers, noncombustible barriers or damp cloth guards shall shield the individual sprinkler heads and shall be removed when the work is completed. If the work extends over several days, the shields shall be removed at the end of each workday.

(2) if fire detection systems were installed and functional:

Approved precautionary measures shall be taken to avoid accidental operation of automatic fire detection systems. For example, the fire alarm system (e.g. smoke detectors) may need to be taken out of service during the hot work operation to avoid unwarranted alarms. The date and time the alarm system was taken off-line, the reason for such action, the name and operator number of the person notified at the central station (or other evidence of notification satisfactory to the Department), and the date and time the system was

restored to service, must be entered in the alarm log book in each such circumstance. Fire watch for impairment must be provided when the alarm system is off-line.

9. Portable fire extinguishers and fire hoses (where provided) are operable and available.
10. All persons performing hot work possess certificates of fitness, where such certificates are required.
  - (1) G-60 certificates of fitness is required for torch operations using oxygen and a flammable gas
  - (2) G-60 or G-41 or G-42 certificates of fitness is required for torch applied roof system.
  - (3) F-60 certificates of fitness fire guard is required to perform the fire watch for torch operations at (a) construction sites, (b) on any rooftop, or (c) in any building or structure, when the torch operation is conducted by a person holding a citywide permit for torch operations
11. All persons performing hot work requiring a permit possess a site-specific permit or citywide permit, authorizing such work.

#### 7.2.4 Fire watch

**HOT WORK.** Cutting, welding, thermit welding, brazing, soldering, grinding, thermal spraying, thawing pipe, cadwelding, installation of torch-applied roof systems or any other similar operation or activity.

**TORCH OPERATION.** Torches and tips that utilize a flammable gas for hot work operations.

**A fire watch must be maintained during ALL hot work operations.** If the hot work operation is utilizing torches, the fire watch must be performed by an F-60 COF holder.

**The fire watch must continue for a minimum of 30 minutes after the conclusion of the work.** The FDNY, or the responsible person (e.g. CSFSM) implementing a hot work program may extend the duration of the fire watch based on the hazards or work being performed at the construction site.

The fire watch must observe the entire hot work area. Hot work conducted in areas with vertical or horizontal fire exposures that are not observable by a single individual must have additional personnel assigned to ensure that exposed areas are monitored.

Persons conducting a fire watch must keep constant watch for fires with respect to the areas being monitored in connection with hot work operations. **The persons conducting a fire watch must not have other duties.**

The fire guards must immediately call 911 if a fire/smoke occurs. The fire guards are trained in the use of portable fire extinguishers and equipped with a portable fire extinguisher, made aware of the location of readily accessible portable fire

extinguishers in the area to which such person has been assigned to maintain a fire watch.

If safe to do so, the fire guards are responsible for extinguishing fires when they are limited in size and spread such that they can readily be extinguished using a portable fire extinguisher.

Where hose lines are required, they must be connected, charged, and ready for operation. A minimum of one portable fire extinguisher complying with the requirements of Fire Code and with a minimum 2-A:20-B:C rating must be provided and readily accessible within a 30 feet travel distance of the location where hot work is performed and where the fire guards are positioned.

**The fire watch for torch operations conducted at the following locations must be conducted by F-60 fire guards:**

▪ **Construction sites**

An F-60 fire guard must be provided for each torch in operation at construction sites, except that a single fire guard may be designated to conduct a fire watch for more than one torch operation on the same floor or level if each torch operation is not more than 50 feet from the fire guard, as measured by the actual path of travel, and the field of view of such fire guard encompasses all of the horizontal fire exposures of such torch operations.

▪ **In any building or structure, when the torch operation is conducted by a person holding a citywide permit for torch operations.**

▪ **On any rooftop or in connection with any torch-applied roofing system operation.**

If the torch operation is being conducted at or near the edge of an unenclosed floor of a building, or near a floor opening or other location where sparks and slag may travel to one or more lower floors or levels, a fire guard must conduct a fire watch on each lower floor or level containing combustible surfaces or materials within 35 feet of the area of such floor or level that potentially would be exposed to such sparks or slag. Prior to commencement of the torch operation, the CSFSM or responsible person must inspect the lower floors or levels and take all necessary and appropriate precautions to protect any combustible surfaces and materials that potentially would be exposed to sparks and slag from the torch operation. A certification to that effect must be made on the hot work authorization.

Exception:

1. A fire watch is not required on the floors or levels below a torch operation on a construction site when:

- the torch operation is not being conducted at or near the edge of an unenclosed floor of a building;
- the floor upon which the torch operation is being conducted is of noncombustible construction;
- there are no floor or exterior building openings within 35 feet of the torch operation; and
- prior to commencement of the torch operation, the CSFSM or responsible person conducts an inspection and takes the precautions required pursuant to Fire Code.

2. Notwithstanding the foregoing exception, if sparks or slag generated by the torch operation are observed to extend beyond 35 feet, thereby potentially exposing lower floors or levels, the torch operation must be immediately discontinued, and the floors or levels below must be inspected for any fire condition. If there is any potential exposure surfaces or materials on the floors below from such sparks and slag, noncombustible barriers must be provided and any other necessary or appropriate precautions must be taken. If such barriers and precautions fail to block the passage of sparks and slag, a fire watch must be established on the floors or levels below.

**It is important to understand the code-required distinction between a fire watch and a fire guard. Not all individuals responsible to maintain a fire watch must possess an F-60 certificate of fitness.**

#### 7.2.5 Discontinued torch operations

When oxygen and acetylene torch operations are not in use, including when such operations are discontinued for the workday, the oxygen and acetylene containers shall be removed from the work area and moved to an approved storage area or removed from the premises.

**Exception:** Brief interruptions in work of not more than 2 hours, including lunch breaks and coffee breaks.

### 7.3 SAFEGUARDING ROOFING OPERATIONS

A torch-applied roof system is a bituminous roofing system using membranes that are adhered by heating with a torch and melting asphalt back coating instead of mopping hot asphalt for adhesion. **It is widely used in US, torch-applied operations can be hazardous to roofers and the public. Improper torch use or careless fire watch has caused many rooftop fires. Fire guards must be on continuous duty during all torch operations on the roof of a building.**

At a construction site and torch-applied roofing system operation, every torch operator must also have a person performing fire watch by an F-60 fire guard.

#### Exception:

The single fire guard may be designated to conduct a fire watch for more than one torch operation on the same floor or level if each torch operation is not more than 50 feet from the fire guard, as measured by the actual path of travel, and the field of view of such fire guard encompasses all of the horizontal fire exposures of such torch operations.

**Fire watch on floors below:** Additional F-60 fire guard is required to perform fire watch on floor below if the torch operation is being conducted at or near the edge of



an unenclosed floor of a building, or near a floor opening, or other location where sparks and slag may travel to one or more lower floors or levels.



Figure 7-2. Fire Watch.

Fire watch is required for adjoining areas and below to make sure that sparks do not cause a fire on the adjoining areas.

This additional fire guard must conduct a fire watch on each lower floor or level containing combustible surfaces or materials within 35 feet of the area of such floor or level that potentially would be exposed to such sparks or slag. Prior to commencement of the torch operation, the fire safety manager or responsible person shall inspect the lower floors or levels and take all necessary and appropriate precautions to protect any combustible surfaces and materials that potentially would be exposed to sparks and slag from the torch operation. A certification to that effect must be made on the hot work authorization.

Exception:

1. A fire watch is not required on the floors/levels below a torch operation on a construction site when ALL the following conditions are met:
  - 1.1. the torch operation is not being conducted at or near the edge of an unenclosed floor of a building;
  - 1.2. the floor upon which the torch operation is being conducted is of noncombustible construction;
  - 1.3. there are no floor or exterior building openings within 35 feet of the torch operation; AND
  - 1.4. prior to commencement of the torch operation, the fire safety manager or responsible person conducts an inspection and takes the precautions to protect any combustible surfaces and materials that potentially would be exposed to sparks and slag from the torch operation.
2. Notwithstanding the foregoing exception, if sparks or slag generated by the torch operation are observed to extend beyond 35 feet, thereby potentially exposing lower floors or levels, the torch operation shall be immediately discontinued, and the floors or levels below shall be inspected for any fire condition. If there is any potential exposure surfaces or materials on the floors below from such sparks and slag, noncombustible barriers shall be provided and any other necessary or appropriate precautions shall be taken. If such barriers and precautions fail to

block the passage of sparks and slag, a fire watch shall be established on the floors or levels below.

The 2009 edition of National Fire Protection Association 51B shows the 35-ft. rule in a 3-D perspective to account for multiple fire watchers. Detail information refer to Chapter 5 of NFPA 51B, 2009 .

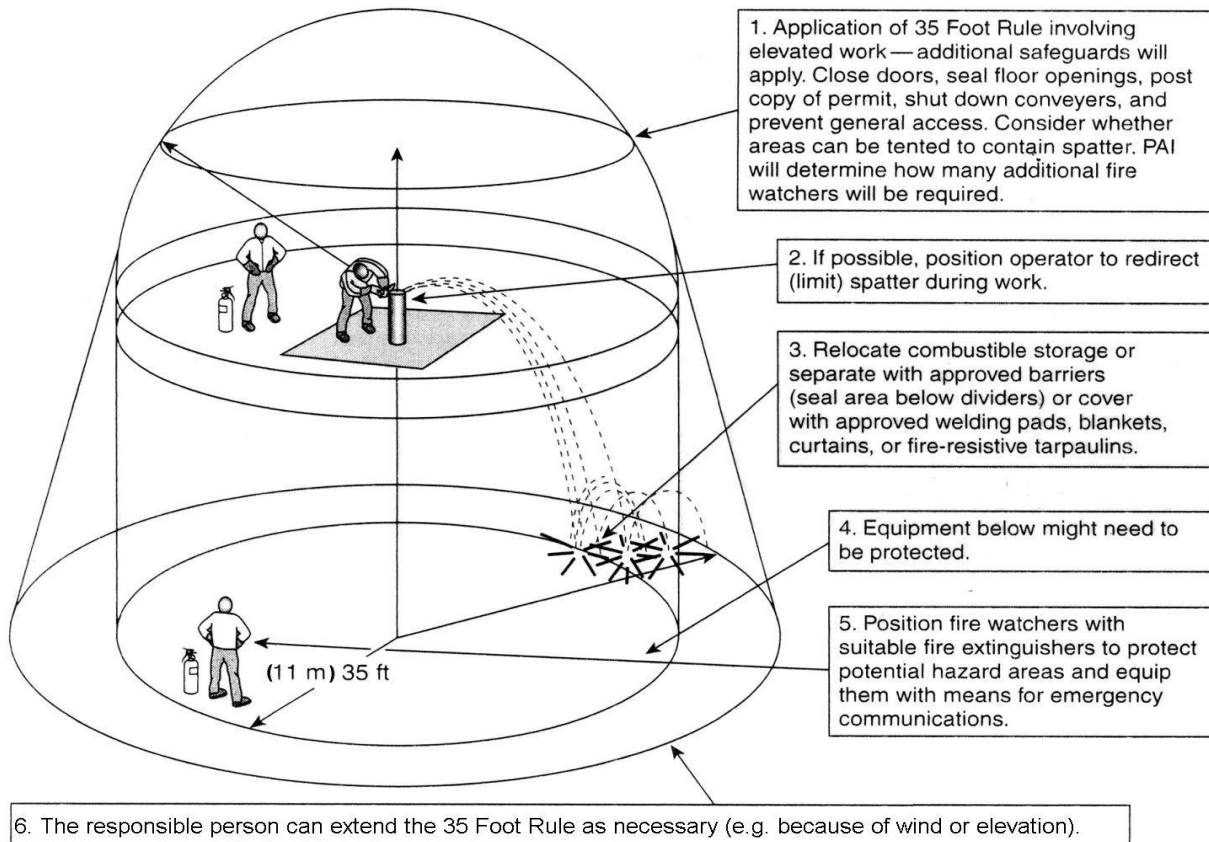

Figure 7-3. Multiple Fire Guards.

### 7.3.1 Fire Extinguisher Requirements

There shall be not less than one multi-purpose portable fire extinguisher with a minimum 3-A 40-B:C rating on the roof being covered or repaired.

### 7.3.2 Prohibited operations

It shall be unlawful to install any roofing material using a torch on a roof of combustible construction, or otherwise engage in roofing operations on roofs of combustible construction using hot work equipment.

## 7.4 **Recordkeeping**

The responsible person for the hot work area must maintain “pre-hot work check” reports in accordance with Fire Code. These reports must be maintained on the premises for a minimum of 48 hours after work is complete.

Revised on 07/2023 (update the NOE-COIB)

The CSFSM must ensure that the report and hot work authorizations are available for inspection during the performance of the work and for 48 hours after the work is complete.

## CHAPTER 8. FLAMMABLE GASES AND OXYGEN

### 8.1 Permit and Certificate of Fitness

Related permit and Certificate of Fitness requirements:

Material / Facility	Permit requirements	Possible C of F	Note
Flammable compressed gases (e.g. acetylene)	The storage, handling and use of compressed flammable gas above 400 SCF (standard cubic feet) requires a permit.	G-44/W-44	<ul style="list-style-type: none"> <li>G-44 is acceptable but W-44 is preferred since W-44 is used for citywide construction site.</li> </ul>
Oxidizing compressed gases (e.g. oxygen)	Store, handle or use oxidizing compressed gases in quantities exceeding 504 SCF.	G-44/W-44	<ul style="list-style-type: none"> <li>G-44 is acceptable but W-44 is preferred since W-44 is used for citywide construction site.</li> </ul>
Liquefied Petroleum Gas (LPG) Compressed natural gas (CNG)	Store or handle LPG/CNG in quantities exceeding 400 SCF (47 pounds of LPG).	G-44/W-44 G-40/ G-41/ G-42/	<ul style="list-style-type: none"> <li>G-44 is acceptable but W-44 is preferred since W-44 is used for citywide construction site.</li> <li>G-40: Use of LPG/CNG for Asphalt Melter or Tar Kettle</li> <li>G-41: Use of LPG/CNG for Torch-Applied Roof Systems</li> <li>G-42: combine G-40 and G-41</li> </ul>
Hot work operations	A permit is required to conduct hot work using oxygen and a flammable gas, such as acetylene or propane.	G-60/ G-41/ G-42/ F-60	<ul style="list-style-type: none"> <li>G-60: Use of Flammable Gases With Oxygen or Use of LPG/CNG for Hot Work Operations</li> <li>G-40: Use of LPG/CNG for Asphalt Melter or Tar Kettle</li> <li>G-41: Use of LPG/CNG for Torch-Applied Roof Systems</li> <li>F-60: Fire Guard for Torch Operations.</li> </ul>

The storage, handling and use of flammable gases shall comply with the requirements of FC Chapters 26, 35 and 38, as applicable.

### 8.2 General Requirements of Compressed and Liquefied Gases

#### 8.2.1 General Requirement

Compressed gas containers are often used at construction sites. All compressed gases are potential hazards because of the pressure within the container, their flammability, and/or their toxicity. The chemical is in gaseous form and pressurized, it can quickly contaminate a large area in the event of a leak.

Compressed gas containers not in use must be stored in an approved storage area.

(1) Labeling all compressed gas container clearly

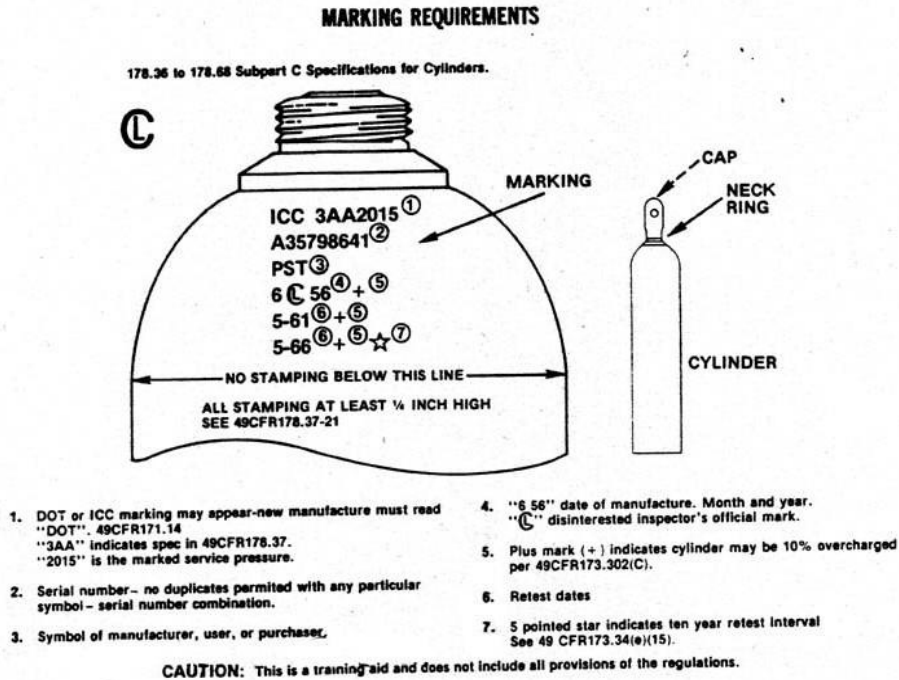

The contents of any compressed gas container must be clearly identified. Gas identification should be stenciled or stamped on the container or a label which shall be marked to show the authorizing code and its working pressure at 70°F. Do not rely solely on the color of the container to identify the contents. Reject any container that is unmarked or has conflicting marking or labels.

(2) Refilling container

The practice of transferring compressed gases from one commercial container to another is not permitted.

(3) Required signs

Compressed gas containers storage areas should be **prominently posted with the names of the gases to be stored**. Where gases of different types are stored at the same location, compressed gas containers should be **grouped by types of gas**, and the groups arranged to take into account the gases contained, e.g. flammable gases must not be stored near oxidizing gases.

Unless otherwise exempted by the Fire Department, hazard identification signs as set forth in NFPA 704 for the compressed gas shall be conspicuously affixed **at entrances** to locations where the containers in quantities requiring a permit are

stored, handled or used, including dispensing, and at such other locations as may be designated by the Fire Department. Individual containers, cartons or packages shall be conspicuously marked or labeled in an approved manner.

Signs reading “**COMPRESSED GAS**” shall be posted at the entrance to rooms or on cabinets containing compressed gases.



Figure 8-1. Signs

All signs and markings required by the Fire Department must not be obscured or removed, must be in English as a primary language or in symbols allowed by the Fire Department, shall be durable, and the size, color and lettering must be acceptable to the Fire Department. Do not repaint gas containers.

(4) Empty containers

**Charged and empty containers should be stored separately** with the storage layout so planned that containers comprising old stock can be removed first with a minimum handling of other containers.

8.2.2 Storing Containers

(1) Upright position

All containers must be secured from tipping over and shall be stored in an upright position and be equipped with a pressure regulator designed for the specific gas and marked for its maximum container pressure. You can use appropriate material, such as chain, plastic coated wire cable, commercial straps, etc., to secure containers. The only exception for storing the compressed gas containers in a horizontal position is those containers with an internal volume is less than 0.174 Cu. Ft. (e.g. lecture bottles).

(2) Gas cabinets

Flammable gas containers shall be separated from oxygen container in the storage enclosures.

Where a gas cabinet is used to increase the maximum allowable quantity per control area or when the location of compressed gases in gas cabinets is provided to comply

with the FDNY requirements, the gas cabinet shall be in accordance with the following regulations:

- The number of containers stored in a single gas cabinet shall not exceed **three**.
- Gas cabinets shall be constructed of not less than 0.097-inch steel; provided with self-closing limited access ports or noncombustible windows to give access to equipment controls; and have all interior surfaces treated, coated or constructed of materials that are compatible with the flammable materials stored.

(3) Incompatible materials

Incompatible compressed gas containers shall be separated from other incompatible materials.

Incompatible gases, shall be separated while in storage except for stored materials in individual containers each having a capacity of not more than **5 pounds**.

Separation shall be accomplished by:

- Segregating incompatible materials in storage by a distance of not less than **20 feet**.

or

- Isolating incompatible materials in storage by a noncombustible partition extending not less than **18 inches above** and to the sides of the stored material.

or

- Storing compressed gases in gas cabinets or exhausted enclosures in accordance with the Fire Code. **Materials that are incompatible shall not be stored within the same cabinet or exhausted enclosure.**

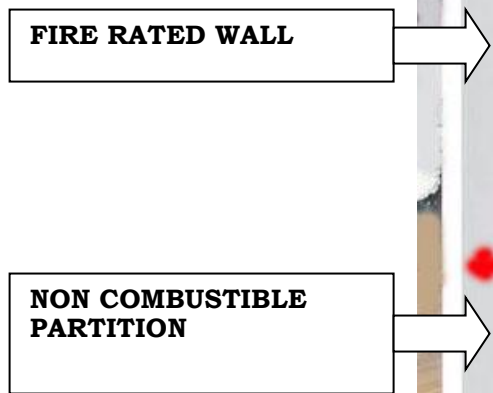

**THE CONTAINER MUST BE CHAINED TIGHTLY!**

#### (4) Separation from hazardous conditions

All compressed gas containers and systems in storage or use shall be away from materials and conditions that present potential hazards to them or to which they present potential hazards. Those containers shall be segregated in hazard classes while in storage, especially be separated from incompatible materials. It is recommended to group containers according to the type of gas (e.g. flammable, oxidizer, toxic or corrosive) or whether containers are full or empty, if they are stored at the same location. **Combustible waste shall be kept a minimum of 10 feet from compressed gas containers and systems.** Generally, corridors are not designed for storage of compressed gases. However, there are circumstances when the FDNY may allow this. Any corridor storage of compressed gases should be approved by the FDNY prior to commencing such storage. Oxidizing gases shall not be stored/used or come in contact with oil, grease, or other petroleum base.

Generally, the compressed gas containers shall be kept away from

- Sources of ignition
- Temperature extremes (Above 125 degrees F or less than mean low atmospheric temperatures)
- Corrosive chemicals or fumes
- Falling objects
- Ledges, unprotected platforms, and elevators or other areas where the container could drop a distance exceeding one-half the height of the container

Compressed Flammable gas containers should be placed at least:

- **20 feet** from all classes of flammable and combustible liquids, oxidizing gases and readily combustible materials, such as paper and combustible fibers.
- **25 feet** from open flames, ordinary electrical equipment or other sources of ignition.
- **50 feet** from air-conditioning equipment, air compressors and intakes of ventilation.
- **50 feet** from another indoor approved flammable gas storage location. (Assuming there is no fire separating wall.)

#### (5) Wiring and equipment

Compressed gas containers and systems shall not be located where they could become part of an electrical circuit. Compressed gas containers and systems shall not be used for electrical grounding.



### 8.2.3 Containers in Use

#### (1) Train Users

Before attempting to connect a container to a system, be certain that the personnel handling the containers are trained and knowledgeable regarding the product, container, fittings, equipment, and proper connection procedures.

#### (2) Regulator use

Containers, when in use, must be connected to gas delivery systems and a regulator instrument. The regulator system shall be equipped with two gauges installed so as to show both the pressure in the container and the pressure in the system.

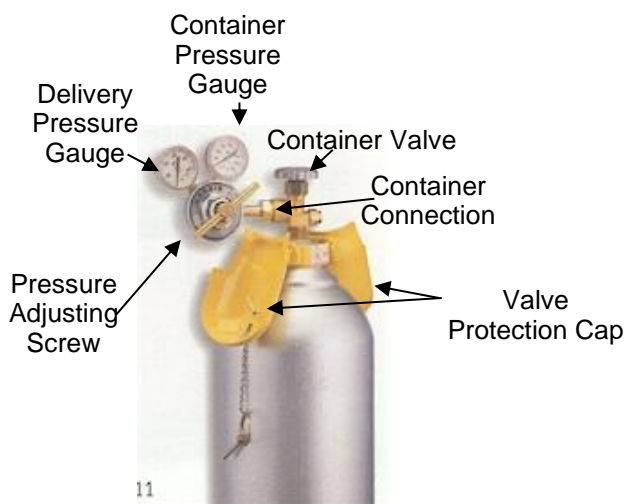

#### (3) Valves

Valves utilized on compressed gas systems shall be suitable for the use intended and shall be accessible. Valve handles or operators for required shutoff valves shall not be removed or otherwise altered to prevent access or hinder operation. Always open the valves slowly and only with the proper regulator in place. Valve protection caps should remain in place until ready to withdraw gas, or connect to a manifold. Before removing the regulator from the container, close the container valve first and release all pressure from the regulator.

#### (5) Containers not in use

In order to decrease the potential hazards for the laboratory personnel, all not “in use” containers, except nominal 11lb propane containers made for consumer use, shall be removed from the laboratory unit to a storage facility (“in use” can include connected to a regulator; connected to a manifold; or an unconnected reserve stored alongside a connected container). Always shut off and have a container cap on any container that is not in use or is being stored.

### 8.2.4 Typical Internal Volume of Cylinders

The following table provides information on the typical internal volume of cylinders:

Model	Nominal Dimension (Diameter x Length*, inch)	Internal Volume (Water volume, Cu. Ft.)
<b>TYPE</b>	<b>STANDARD CYLINDER SIZES AND CAPACITIES (NFPA 45)</b>	
Lecture Bottle	2 x 15	0.016
D	4.5 x 18	0.08
E	4.5 x 31	0.164
M	7 x 43	0.77
G	9 x 55	1.54
H	9 x 60	1.75
<b>LPG WEIGHT</b>	<b>COMMON LPG CONTAINER SIZES AND CAPACITIES</b>	
16.4 oz.	4¼ x 6¼	0.051
5 lbs.	9 ¾ x 12½	0.192
20 lbs.	12 ⅛ x 20⅛	0.769
<b>TYPE</b>	<b>COMMON ACETYLENE CONTAINER SIZES AND CAPACITIES</b>	
B (40 SCF)	6 x 25	0.278
WC (110 SCF)	8½ x 33½	0.885
WK (330 SCF)	13 x 42	2.414

\* Includes valve and cap

8.2.5 Compressed Gas Container Disposal or Return

It is dangerous to empty a compressed gas container completely, a container is considered empty when the container pressure is at atmospheric pressure or 15 psia (pounds per square inch absolute) remaining. The empty containers shall be labeled with the word “empty” or the abbreviation “MT and the date”. Always handle empty containers as carefully as full ones; residual pressure can be dangerous.



Figure 8-2. Examples of the gas container tag

### 8.3 LPG/CNG storage at construction sites

No LPG/CNG container is allowed to stored underground or in a below grade location.

The W-44/G-44 Certificate of Fitness holder is responsible for the safe storage and use of the gas containers. The LPG/CNG storage must be located away from the following: Electric power lines; Piping containing flammable or combustible liquids; Piping containing flammable gases; and Piping containing oxidizing materials.

LPG/CNG containers must be stored in a storage enclosure and must be approved by FDNY. The enclosure must protect the containers against extreme temperatures, tipping over, physical damage, and tampering. They also must be protected by a metal open fence enclosure at least 6 feet in height, and secured by a locked gate opening outward or a lockable ventilated metal locker of a type acceptable to the Fire Department. Such fence enclosure or locker must be mounted on and secured to a substantial concrete pad at grade level, protected to prevent accumulation of rain and snow.



Figure 8-3. Acceptable storage enclosure.

Warning signs complying with OSHA requirements must be conspicuously posted at each LPG/CNG installation, storage location or use site.



(The sign must be at least 10 inches by 14 inches in size and the letters must be at least 2 inches high)

Figure 8-4. Sign

**Acceptable:**

- The metal open fence enclosure was secured by a locker. Such enclosure must be mounted on and secured to a substantial concrete pad at grade level.
- The storage was located in a well ventilated area.
- The required sign was conspicuously posted.



**Unacceptable:**

- **The fire extinguisher should be mounted:** The clearance between the bottom of the extinguisher and the floor must not be less than 4 inches.
- Construction site storage enclosure shall be equipped with at least one 40-B/C rated, wheeled, fire extinguisher.

The W-44/G-44 Certificate of Fitness holder is responsible for the safe storage, handling and use of the LPG/CNG containers. Only LPG/CNG containers in use are permitted inside a building under construction. No extra containers may be located in the building while work is in progress. Generally, LPG/CNG containers are not allowed to be stored inside any unoccupied building overnight and should be taken outside at the end of each work day. However, there are circumstances when the Fire Department may allow this. **Any indoor storage of LPG/CNG containers must be approved by the Fire Department prior to commence such storage.** All

indoor storage must be at least 10 feet away from any flue, stairwell or elevator shaft. **LPG/CNG containers must not be stored on the roof of any building.**

The maximum allowable quantity of LPG and CNG on construction sites:

	LPG	CNG	Note
Single outdoor storage enclosure	2500 pounds	21,500 SCF	The distance between two locations on a construction site must be at least 50 feet.
Single indoor storage location	1250 pounds	10,625 SCF	The distance between two locations on a construction site must be at least 70 feet.
Total capacity on a construction site	5000 pounds	42,500 SCF	

**Any single standard portable LPG container must not exceed 100 lbs in weight. Any single CNG container must not exceed 381 SCF. All empty or in-use gas containers should be counted as full containers. In other words, the quantity of any empty gas container must be subject to the maximum allowable storage quantity.** All LPG/CNG containers, full or empty, and which are not in use must be stored in an outdoors storage enclosure. The location of the outdoor storage enclosure must comply with the following distance requirements:

**LPG/CNG OUTDOOR STORAGE ENCLOSURE LOCATION**

Type of Outdoor Exposure	Minimum Distance to the Exposure
Any combustible materials (e.g. paper box)	50 feet
The nearest lot line, sidewalk, or building on an adjoining lot	10 feet
Any authorized parking for motor vehicles	10 feet
Any below ground flammable liquid or combustible liquid storage tank in excess of 1,000 gallons.	15 feet
Building openings or any exit access doors, or stairways.	20 feet
Motor vehicle fuel dispenser (e.g. Gas station)	20 feet
The building under construction	25 feet
Any building occupied as a multiple dwelling	50 feet
<u>Any subway entrance, exit, vent or other opening</u>	100 feet
<u>Any school, hospital, church, or place of public assembly.</u>	100 feet

Each construction site storage enclosure shall be equipped with at least one 40-B/C rated, wheeled, fire extinguisher. Such fire extinguisher must be kept outside of the storage facility or placed at another readily accessible location not more than 30 feet from the storage facility.



Figure 8-5. Wheeled 40 lb. Fire Extinguisher

#### **8.4 Portable liquid oxygen containers and oxygen trailer**

At some large construction sites, portable liquid oxygen containers and oxygen trailers may be used. The storage, handling and use of portable liquid oxygen containers and oxygen trailer shall comply with FC1406.2. Refer to Appendix B for detail.

#### **8.5 Oxygen and acetylene gases used for torch operation**

Oxygen and acetylene containers used for torch operations may be stored on the floors on which the torch work is being conducted only in an unoccupied building and only in an approved storage area. Oxygen or acetylene containers, other than those necessary for the day's torch operations, shall be considered as reserve storage, and shall not be stored on such floors.

##### **8.5.1 Containers connected for use.**

A single container of oxygen and a single container of flammable gas may be installed on a cart without separating these two containers 20 feet apart provided that:

- The containers are connected to regulators, equipped with apparatus designed for cutting, welding or other hot work operation,
- The containers are otherwise ready for use,
- The carts are designed and used in accordance with FC2703.10.3.
- Container valves have a fixed hand wheel, or other approved means by which the flow of gas may be immediately shut down during hot work operations.
- Container valves are closed at the end of each workday and whenever work is discontinued or the cart moved.
- Container valve outlet connections shall conform to the requirements of CGA V-1.
- Separation of the cart from the hot work operation shall be maintained in accordance with FC2605.5, or fire-resistant shields shall be provided.
- A separation distance of 20 feet shall be maintained between such carts.

### 8.5.2 Storage requirements

Maximum aggregate indoor acetylene storage quantities. The aggregate of the indoor storage of acetylene authorized must not exceed 15,000 SCF.

Oxygen and acetylene storage areas on the floors on which the torch work is being conducted shall comply with the following requirements:

#### **Distance requirements:**

**Acetylene** storage shall be protected against damage or injury from falling objects or surrounding activity, and be located not less than:

- **20 feet** from all classes of flammable and combustible liquids, **oxidizing gases** and readily combustible materials, such as paper and combustible fibers.
- 25 feet from open flames, ordinary electrical equipment or other sources of ignition.
- 50 feet from air-conditioning equipment, air compressors and intakes of ventilation.
- 50 feet from other flammable gas storage.

#### **Maximum quantity of acetylene containers**

The maximum quantity of acetylene containers stored on any floor shall not exceed 3,500 SCF.

#### **Storage cabinet**

Oxygen and acetylene containers shall be located within a compressed gas storage cabinet designed and secured to prevent unauthorized entry. The storage cabinet shall be conspicuously marked with a hazard identification sign.

### 8.5.3 Reserve oxygen and acetylene containers.

#### 1. Indoor storage

Indoor reserve storage of acetylene containers shall be allowed only when outdoor storage is unavailable on the premises, the building is unoccupied, the containers are stored on the ground floor of the building, and the total quantities stored do not exceed 3,500 SCF.

#### 2. Outdoor storage

Outdoor reserve acetylene container storage areas shall not exceed 3,500 SCF. More than one outdoor storage area may be authorized on the premises provided the distance from each outdoor storage area to each exposure identified in FC Chapter 35 complies with the requirements of FC Chapter 35.

#### 3. Distance requirements:

Storage shall not be located where the stored flammable gases would be exposed to the following hazards in the event of the failure of their structure or containment systems:

1. Electric power lines.

2. Piping containing flammable or combustible liquids.
3. Piping containing flammable gases.
4. Piping containing oxidizing materials.

**DISTANCE FROM OUTDOOR FLAMMABLE GASES STORAGE AREAS (more than 1500 SCF up to Maximum 3500 SCF) TO EXPOSURES**



<b>TYPE OF OUTDOOR EXPOSURE</b>	<b>MINIMUM DISTANCE TO OUTDOOR EXPOSURE (FEET)</b>
Building or structure of combustible construction	10
Building or structure of noncombustible construction	5
Flammable and combustible liquids Aboveground – 1,000 gallons or less	10
Flammable and combustible liquids Aboveground – in excess of 1,000 gallons	20
Flammable and combustible liquids Underground tank – 1,000 gallons or less	10
Flammable and combustible liquids <ul style="list-style-type: none"> <li>• Underground tank – 1,000 gallons or less (Vent or fill opening of tank)</li> <li>• Underground tank – in excess of 1,000 gallons</li> <li>• Underground tank – in excess of 1,000 gallons (Vent or fill opening of tank)</li> </ul>	15
Flammable gas storage area, any pressure 1,500 SCF or less	10
Flammable gas storage area, any pressure More than 1,500 SCF up to maximum 3,500 SCF	20
Oxygen storage – 20,000 SCF or less	In accordance with NFPA 51
Oxygen storage – in excess of 20,000 SCF	In accordance with NFPA 55
Combustible material or combustible waste	10
Public streets, private roads and lot lines	10
<b>The minimum required distances listed above shall be reduced to 5 feet when protective structures having a minimum fire-resistance rating of 2 hours interrupt the line of sight between the container and the exposure.</b> The protective structure shall be at least 5 feet from the exposure. The configuration of the protective structure shall be designed to allow natural ventilation to prevent the accumulation of hazardous gas concentrations.	
Building openings	10
Air compressor intakes or inlets to ventilating or air-conditioning equipment	5
Group A occupancies and public gathering places	25
Public sidewalks and parked motor vehicles	10



4. Storage cabinet:

Oxygen and acetylene containers shall be located within a compressed gas storage cabinet designed and secured to prevent unauthorized entry.

The storage cabinet shall be conspicuously marked with a NFPA diamond hazard identification sign and Signs reading “COMPRESSED GAS” shall also be conspicuously posted at the entrance to rooms or on cabinets containing compressed gases.

Figure 8-4. NFPA 704 diamond sign of Oxygen	Figure 8-5. NFPA 704 diamond sign of acetylene
	

## CHAPTER 9. FLAMMABLE AND COMBUSTIBLE LIQUIDS

### 9.1 Class Flammable and Combustible Liquids

For the current fire code, there are 3 classes of flammable liquids and 3 classes of combustible liquids defined as the following table.

**Class of Flammable and Combustible Liquids**

		<b>Flash point</b>	<b>Boiling point</b>	<b>Examples</b>
<b>Flammable liquids (Class I liquids)</b>	<b>Class IA</b>	< 73°F	< 100°F	<b>Gasoline</b> , Acetaldehyde, Ethyl ether, Formate, Pentane
	<b>Class IB</b>	< 73°F	≥ 100°F	Acetone, Ethanol, Methyl alcohol, Propyl alcohol
	<b>Class IC</b>	≥ 73°F but < 100°F	Not Applicable	Turpentine, Butyl alcohol, Hydrazine, Styrene
<b>Combustible liquids (Class II &amp; III liquids)</b>	<b>Class II</b>	≥ 100°F but < 140°F	Not Applicable	Kerosene, <b>Diesel</b> , WD-40 lubricant
	<b>Class IIIA</b>	≥ 140°F but < 200°F	Not Applicable	Butyric Acid, Creosote Oil
	<b>Class IIIB</b>	≥ 200°F	Not Applicable	Formalin, Glycerine, Picric acid, Propylene glycol

### 9.2 FDNY Permit and Certificate of Fitness

An FDNY permit is required to store, handle or use:

1. Class I liquids, other than paints, varnishes, lacquers, gasoline and other petroleum-based Class I liquids, in quantities exceeding 5 gals.
2. Gasoline and other petroleum-based Class I liquids other than paints, varnishes and lacquers, in quantities exceeding 2½ gals.
3. Class II or Class III liquids with a flash point of 300°F or less, other than paints, varnishes and lacquers, in quantities exceeding 10 gals.
4. Class I, Class II or Class III liquids having a flash point of 300°F or less that are commonly used for painting, varnishing, staining or other similar purposes, including paint, varnish and lacquer, in quantities exceeding 20 gals.
5. Fuel oil in quantities exceeding 10 gallons on mobile heating and power generating trailers.

Storage, handling and use of flammable and combustible liquids shall be in accordance with FC 3406.2 and such other provisions of FC Chapter 34 (including

but not limited to 3403.3, 3404.4, 3405.2 as may be applicable to the specific construction site material or operation.

The storage of flammable liquids, and combustible liquids with a flash point of 300°F or less, shall be under the general supervision of **an S-93 Certificate of Fitness holder** when the quantity of such stored liquids at a construction site exceeds the following amounts:

- 275 gallons in a closed system;
- 275 gallons of alcohol-based hand rubs;
- 20 gallons of combustible liquid in portable containers;
- 10 gallons of flammable liquid in portable containers, except alcohol-based hand rubs and gasoline; or
- 2½ gallons of gasoline.

The handling and use of flammable liquids, and combustible liquids with a flash point of 300°F or less, shall be under the personal supervision of an S-93 Certificate of Fitness holder when the quantity of such handled and used liquids exceeds the amounts listed above.

The CSFSM must ensure that the FDNY permits are readily available on the construction site and the flammable liquids and combustible liquids are under the supervision of S-93 Certificate of Fitness when required. The CSFSM also needs to ensure all applicable standards and rules are being complied with.

### **9.3 Housekeeping**

Adequate ventilation shall be provided for operations involving the application of materials containing flammable solvents. Adequate ventilation means ventilation by natural or mechanical methods to allow the free flow of air that remove flammable vapors to prevent hazardous conditions. The ventilation rate shall be adequate to maintain the concentration of flammable vapors in the area at or below 25 percent of the lower flammable limit (LFL).

Flammable and combustible liquid storage areas shall be maintained clear of vegetation and combustible waste. Such storage areas shall not be used for the storage of combustible materials. All flammable and combustible liquids must be clearly identified on the containers.

Sources of ignition and smoking shall be prohibited in flammable and combustible liquid storage areas. “No Smoking” signs in compliance with the requirements of FC310 shall be conspicuously posted. Class I and II liquids shall be stored in approved safety containers.

Leaks in flammable or combustible liquid containers should be taken very seriously. In some cases, the residual vapors are more dangerous than the liquids. For

example, gasoline vapors are more flammable than liquid gasoline. Leaking containers shall be immediately repaired or taken out of service.

Spills shall be cleaned up immediately and all liquid and waste material disposed of lawfully. The Fire Department must be immediately notified in case of a large spill of flammable or combustible liquid (e.g. equal to or more than 5 gallons).

In addition, all petroleum spills (e.g. gasoline or diesel) that occur within New York State (NYS) must be reported to the NYS Spill Hotline (1-800-457-7362) within 2 hours of discovery, except spills which meet ALL of the following criteria:

- i. The quantity is known to be less than 5 gallons; and
- ii. The spill is contained and under the control of the spiller; and
- iii. The spill has not and will not reach the State's water or any land; and
- iv. The spill is cleaned up within 2 hours of discovery.

A spill is considered to have not impacted land if it occurs on a paved surface such as asphalt or concrete. A spill in a dirt or gravel parking lot is considered to have impacted land and is reportable.

More details on notification and reporting requirements can be found in the document posted by the Department of Environmental Conservation ([http://www.dec.ny.gov/docs/remediation\\_hudson\\_pdf/1x1.pdf](http://www.dec.ny.gov/docs/remediation_hudson_pdf/1x1.pdf)). (The spill responses can be referred to <http://www.dec.ny.gov/chemical/8692.html>)

## 9.4 Storage

Where flammable or combustible liquids in use at a construction site are not removed from the job site at the end of the workday they shall be stored in a **metal flammable liquid storage cabinet** when not in use. Flammable or combustible liquids may be stored on a roof in connection with work on a **roof** in a quantity not to exceed one day's supply, but in **no case more than 20 gallons**.

The storage of any liquids shall not be stored near or be allowed to obstruct physically the route of egress. Containers shall be stored in an upright position.

Flammable and combustible liquid shall only be stored in **metal containers** of a type meeting the requirements of the regulations of the United States Department of Transportation, as set forth in 49 CFR Part 178, or in containers of an approved design.

The outdoor storage area must be graded in a manner to divert possible spills away from building or other exposures or must be surrounded by a curb at least 6 inches high

### 9.4.1 Quantity limits for containers storage

It shall be unlawful to store flammable and combustible liquids in portable containers with individual capacity greater than **60 gallons**. Only the approved containers complying with NFPA30 must be used for Class I, Class II, and Class IIIA liquids. **It shall be unlawful to store flammable and combustible liquids in portable tanks, intermediate bulk containers and fiber drums.**

### 9.4.2 Liquid storage cabinets

Where the Fire Department requires that liquid containers be stored in storage cabinet, such cabinets and storage shall be in accordance with the followings:

The cabinet must be listed in accordance with UL 1275. All cabinets must be provided with a conspicuous label in red letters on contrasting background which reads: **FLAMMABLE-KEEP FIRE AWAY**. The door must be **well fitted, self-closing and equipped with a three-point latch**. The bottom of the cabinet must be **liquid-tight** to a height of at least 2 inches.



The combined total quantity of liquids in a cabinet shall **not exceed 120 gallons** or the manufacture's recommendations whichever is less. **Maximum 3 cabinets is allowed to be located in a single fire area**, additional cabinets are allowed to be located in the same fire area if the additional cabinets (or groups of up to 3 cabinets) are separated from other cabinets or groups of cabinets by at least **100 feet**.

**Quantities of flammable and combustible liquids requiring a permit, used for maintenance purposes and the operation of equipment, shall be stored in liquid storage cabinet.** Quantities not requiring a permit are allowed to be stored outside of a cabinet when in approved containers and locations.

#### 9.4.3 Empty containers

Empty containers shall be considered as full containers. The storage of empty containers previously used for the storage of flammable or combustible liquids shall be stored as required for filled containers. **Empty containers shall be removed from the premises as soon as practical, but at least daily.** Depending on the type of material previously stored in the container, empty containers can be more hazardous than full containers.

#### 9.4.4 Protections and clearance from combustibles

Storage areas shall be protected against tampering or trespassers or other approved control measures. Posts or other means shall be provided to protect outdoor storage tanks from vehicular damage.

The storage location shall be kept free from vegetation and other combustible waste. **Rubbish and other combustible waste shall not be allowed to accumulate within 15 feet of a flammable or combustible liquid storage location.** Brush, grass, vines, weeds and other vegetation capable of being ignited that is located within 15 feet of a flammable or combustible liquid storage location shall be regularly mowed or pruned and the clippings removed from the premises.

#### 9.4.5 Tank Storage

Prior to a change in contents, the FDNY commissioner may require testing of a tank for leaks and documentation of compatibility. Tanks that have previously contained Class I liquids shall not be loaded with Class II or Class III liquids until such tanks and all piping, pumps, hoses and meters connected thereto have been completely drained and flushed.

### **9.5 LABELING AND SIGNS**

#### 9.5.1 NFPA Diamond Sign

Unless otherwise exempted by the FDNY commissioner, hazard identification (diamond) signs are required for specific materials as set forth in NFPA 704. These signs shall be conspicuously affixed on stationary containers and aboveground tanks and at entrances to locations where hazardous materials are stored, handled or used, including dispensing, in quantities requiring a permit, including locations where such materials are dispensed, and at such other locations as may be designated by the FDNY.

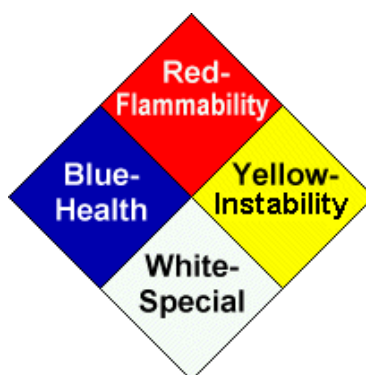

Figure 9-3. NFPA 704 diamond sign

The NFPA National Fire Protection Association ([www.nfpa.org](http://www.nfpa.org)), a private, non-profit organization that produces technical data related to fire protection and prevention, including the widely used NFPA diamond containing codes representing chemical hazards. 704 diamond (sometimes called the "fire diamond") is a standard placard used to quickly identify a chemical's level of hazard. The diamond sign is divided into 4 quadrants:

- Within the blue, red, and yellow quadrants a number from 0 to 4 indicates the degree of risk associated with the chemical. The higher the number, the higher the risk.
- For some chemicals, the white quadrant contains symbols indicating special hazards.

<b>Special Hazard</b>	<b>“W”</b>	The materials that react violently or explosively with water (water reactivity rating of 2 or 3).
	<b>“OX”</b>	The materials that possess oxidizing properties. The severity of the hazard posed by an oxidizer can be divided in to 4 classes from Classes 1 through 4. The adding of the quantification of the oxidation helps to better define the hazard. For example, for the material categorized as a Class 2 oxidizer (e.g. calcium chlorite) can be marked <b>“OX 2”</b> to better define the hazard.

### 9.5.2 Warning Signs and Labels

Signage for identification and warning such as for the inherent hazard of flammable liquids or prohibiting smoking shall be provided. Signs and markings shall not be obscured or removed, shall be in English as a primary language or in symbols allowed by this code, shall be durable, and the size, color and lettering shall be acceptable to the commissioner. The FDNY commissioner may require warning signs for the purpose of identifying the hazards of manufacturing, storing, handling or using flammable liquids, including the dispensing or mixing of such liquids.

#### (1) Warning signs

Tanks and containers for aboveground storage of liquids shall be conspicuously marked with the name of the product which they contain and the words:

FLAMMABLE—KEEP FIRE AND FLAME AWAY. Tanks shall bear the additional marking: KEEP 50 FEET FROM BUILDINGS.



Figure 9-4. An example of the warning sign

(2) No-smoking signs



Figure 9-5. Examples of acceptable no-smoking signs

(2) Labels

Individual containers, packages and cartons shall be identified, marked, labeled and placarded in accordance with federal regulations and applicable state laws.

Tanks more than 100 gallons in capacity, which are used for the storage of Class I, II or IIIA liquids, shall bear a label and placard identifying the material therein. Placards shall be in accordance with NFPA 704.



## **CHAPTER 10. PORTABLE FUELED SPACE HEATERS**

### **10.1 FDNY Permit and Certificate of Fitness requirements**

Portable Space Heater: Any portable equipment designed or used for space heating that utilizes a combustible liquid or flammable gas as a fuel, whether or not flue-connected.

An FDNY permit is required to store, handle or use portable fueled space heaters that are fueled:

- by a combustible liquid.
- by compressed natural gas (CNG).
- by liquefied petroleum gas (LPG).
- by piped natural gas, except in Group R-3 occupancies.

An FDNY permit is also required prior to the storage, handling or use of coke-fueled salamanders at a construction site.

The handling and use of portable fueled space heaters or coke and coke-fueled salamanders at a construction site shall be under the personal supervision of a person holding an S-92 certificate of fitness.

The storage of portable fueled space heaters, and the fuel therefore, and/or coke and coke-fueled salamanders at a construction site shall be under the general supervision of an S-92 certificate of fitness holder.

The Construction Site Fire Safety Manager must ensure the valid FDNY permit, if required, is issued and the S-92 Certificate of Fitness holder is present at the construction site while the portable fueled space heater is handled or used.

The CSFSM must ensure that the FDNY permits are readily available on the construction site and the portable space heaters are under the supervision of S-92 Certificate of Fitness. The CSFSM also needs to ensure all applicable standards and rules are being complied with.

Note: The storage of LPG/CNG containers must be under the general supervision of W-44/G-44 Certificate of Fitness holder. The storage of combustible liquids that used for space heaters must be under general supervision of S-92 or S-93 Certificate of Fitness holder.

### **10.2 Installation and Protection**

Clearance to combustibles from portable fueled space heaters shall be maintained in accordance with the manufacturer's specifications and applicable fire code regulations. When in operation, portable fueled space heaters shall be fixed in place and protected from overturning, movement or damage in accordance with the manufacturer's specifications.

The heating element or combustion chamber shall have a permanent device to prevent accidental contact by persons or material.

All portable fueled heaters shall be located

- outdoors,
- at least 5 feet from any building or structure,
- at least 5 feet from combustible decorations and combustible overhangs, awnings, sun control devices or similar combustible attachments to buildings or structures, and
- at least 5 feet from exits or exit discharges

Refueling operations shall be conducted in accordance with FC3405. Portable fueled space heaters shall be shut down and cool to the touch before refueling.

#### 10.2.1 Escape hatches

Where portable fuel fired heaters or other heating equipment are used to provide temporary heating during the placing of concrete for a floor, an escape hatch shall be provided. The escape hatch shall extend from the floor where the concrete is being placed and through at least one story immediately below such floor. The escape hatch shall be located as near to the center of the building or structure as practical.

Exception:

An escape hatch is not required provided at least one permanent stairway is available for use on the floor where such concrete placement is occurring and that such stairway is enclosed from the ceiling to the floor of the floor where such concrete placement is occurring and from the ceiling to the floor immediately below such floor with the permanent fire-rated enclosure for the stair or a fireproof tarp wrapped tightly around the stair shaft so that no smoke can penetrate.

#### ***Required ladders and metal shields.***

The escape hatch shall be constructed with at least two fixed, vertical ladders enclosed in a metal shield. The ladders shall extend from a distance of 3 feet (914 mm) above the floor where concrete is being placed to either at least two stories below, or to the ground floor, whichever is less. The metal shield shall enclose the ladders on all sides from the top of the floor where the concrete is being placed to at least the top of the floor next below. The inside dimensions between faces of the shield shall be not less than 3 feet 8 inches.

Exception:

Extension ladders may be utilized where the horizontal dimension between the faces of the shields is equal to or greater than one-quarter the height of the shaft.

#### ***Shield space and decking.***

The space between the shield and the perimeter of the opening in the floor under construction and also between the shield and the perimeter of the opening in the floor next below shall be decked over with 2-inch or heavier planking covered with

plywood or sheet metal so as to make the decking smoke tight. At the termination of the ladders, the opening in the floor shall be covered completely with 2-inch planking or other material of equivalent strength.

### **10.3 Portable Oil-Fueled Heater**

Portable oil-fueled space heaters may be stored, handled and used at construction sites for construction-related curing and drying purposes during the heating season beginning on October 15 and ending on May 30 of the following year, and at such other times of year as may be authorized by permit. Such heaters shall be stored, handled and used in accordance with the Fire Code.



Figure 10-1. Kerosene Forced Air Portable heater

### **10.4 Portable Gas-Fueled Heater**

Portable gas-fueled space heaters utilizing liquefied petroleum gas (LPG), compressed natural gas (CNG) and piped natural gas may be stored, handled and used at construction sites for construction-related curing and drying purposes during the heating season beginning on October 15 and ending on May 30 of the following year, and at such other times of year as may be authorized by permit. Such heaters shall be stored, handled and used in accordance with the Fire Code.

#### **10.4.1 Portable space heaters fueled by piped natural gas**

The heaters shall be located outdoors and at least 5 feet from

- any building or structure;
- combustible decorations and combustible overhangs, awnings, sun control devices or similar combustible attachments to buildings or structures;
- exits or exit discharges.

The heaters shall be equipped with a tilt or tip-over switch that automatically shuts off the flow of gas if the appliance is tilted more than 15 degrees (0.26 rad) from the vertical.

The heating element or combustion chamber of heaters shall be permanently protected so as to prevent accidental contact by persons or material.

(1) Prohibited operations.

It shall be unlawful to store or use a portable space heater fueled by piped natural gas at a construction site:

- (A) for human comfort or any purpose other than construction-related curing and drying;
- (B) for construction-related curing and drying, without a Department permit;
- (C) in any part of the building under construction that is occupied;
- (D) in any part of the building under construction that is located within ten (10) feet of any opening in a wall of an occupied adjacent structure or building, or within 50 feet of any building occupied for educational, health care or religious purposes, place of public assembly or other place of public gathering;
- (E) at any construction site at which there is no shut-off valve for the piped natural gas service installed outside of the building under construction in accordance with the requirements of the Construction Codes; or
- (F) where pressure of supply to piped natural gas to the building under construction is more than one-half ( $\frac{1}{2}$ ) psig.

## (2) Inspection

The S-92 Certificate of Fitness holder shall periodically inspect all portable space heaters fueled by piped natural gas at a construction site. Such inspections shall be conducted as frequently as needed to ensure the safe operation of the heaters, considering the nature and location of the curing or drying operation and surrounding activities at the construction site, but in no event less than once every four (4) hours. All portable space heaters fueled by piped natural gas that are connected for use but not in use, and all natural gas piping and equipment installed at the construction site, including the outdoor gas service line shut-off valve, shall be inspected at least once every work day.

The S-92 Certificate of Fitness holder shall ensure that all such appliances, piping and equipment are in a safe condition and proper working order and are otherwise installed, maintained and operated in compliance with the requirements of this section. Any appliance, piping or equipment that is not in a safe condition or proper working order shall be immediately disconnected, promptly removed from the premises, and not returned to service unless restored to a safe condition or good working order.

The S-92 Certificate of Fitness holder needs to ensure the design, installation, operation and maintenance of the heaters comply with Fire Rule § 1403-01.

The results of each inspection shall be recorded in the log book which will be maintained on the premises and produced for inspection when requested by FDNY.

## (3) Portable Fire Extinguisher

A portable fire extinguisher with at least a 20-B:C rating shall be provided on each floor of the construction site at a location not more than 30 feet from where a heater is in use or connected for use. A travel distance of up to 50 feet is allowed if a portable fire extinguisher with at least a 40-B:C rating is provided.

### 10.4.2 Portable space heaters fueled by LPG

The storage, handling and use of LPG and LPG equipment shall be in accordance with this section and FC Chapter 38.

The storage, handling and use of CNG and CNG equipment shall be in accordance with this section and FC Chapter 35.

LPG space heaters are typically used for drying plaster, and similar wet trade applications. **LPG space heaters are prohibited in any occupied building.** The use of LPG space heaters must be conducted under the supervision of a person holding an S-92 Certificate of Fitness.

The S-92 Certificate of Fitness holder should inspect the area where the LPG/CNG containers and heaters are located at least on an hourly basis. The results of each inspection shall be recorded in the logbook which will be maintained on the premises and produced for inspection when requested by FDNY. All storage and use must be approved by FDNY. The CSFSM is responsible to ensure that the S-92 COF holder making the record and ensure that the logbook is maintained on site.

Storage of LPG/CNG cylinders should be under general supervision of a W-44/G-44 Certificate of Fitness holder.



Figure 10-2. Propane radiant heater



Figure 10-3. Safe LPG Cylinder Storage



Figure 10-4. Natural Gas Salamander



Figure 10-5. Compressed Natural Gas (CNG) cylinders

## 10.5 Coke-fueled Salamanders

Coke-fueled salamanders shall consist of a metal vessel, inner grate and ash pan, which shall be fabricated in compliance with Fire Rule 307-01.



Figure 10-6. Salamander with coke burning



Figure 10-7. Empty salamander

### 10.5.1 Prohibited operations

It shall be **unlawful** to:

- (1) use a coke-fueled salamander at any location other than a construction site at which construction work is being performed pursuant to a work permit issued by the Department of Buildings;
- (2) use a coke-fueled salamander at a construction site where the sprinkler system and/or standpipe system required by the Building Code is out of service, or any part of such system is out of service, in the area in which coke or coke-fueled salamanders are being handled or used;
- (3) use a coke-fueled salamander for purposes of human comfort, or any other purpose other than construction-related drying or curing;
- (4) store, handle or use a coke-fueled salamander at a construction site without a permit;
- (5) store, handle or use coke or a coke-fueled salamander at a construction site without the requisite supervision;
- (6) use a flammable liquid, combustible liquid or any other type of accelerant to ignite or reignite the coke;
- (7) use a coke-fueled salamander at a construction site in any of the following locations:
  - (A) on a scaffold;
  - (B) in any occupied building;
  - (C) on any floor where hazardous materials are stored or are in use;
  - (D) on any floor that is of combustible construction;
  - (E) within ten (10) feet of any wall opening of an adjoining occupied building;or

- (F) within 50 feet of any building occupied for educational, health care or religious purposes, place of assembly or other place of public gathering.

### 10.5.2 Operation and Inspection Requirements

The operation of coke-fueled salamanders must be under personal supervision of an S-92 Certificate of Fitness holder.

An S-92 Certificate of Fitness holder may not supervise the handling or use of more than 50 coke-fueled salamanders, or the handling or use of coke or coke-fueled salamanders that are located on more than one floor.

Periodic inspections of coke-fueled salamanders required to be conducted by the certificate of fitness holder

The operation of coke-fueled salamanders must comply with the following requirements:

- (1) Coke-fueled salamanders in use shall be placed at least ten (10) feet from combustible material, except that such salamanders may be placed not less than 24 inches from wooden column form work or such further distance as will ensure that the form work does not attain temperatures equal to or greater than 194 degrees Fahrenheit and is not charred.
- (2) The ash pan shall be placed and positioned under the salamander. A layer of moistened sand shall be placed in the ash pan prior to use of the coke-fueled salamander. The ash pan shall be regularly emptied, so as to prevent ash from spilling over the lip of the ash pan.
- (3) Coke-fueled salamanders shall be loaded with coke to not more than two-thirds (2/3) of the vessel's capacity, and **ignited by the S-92 Certificate of Fitness holder using an approved LPG-fueled torch having an LPG container capacity of not more than 20 pounds.**
- (4) Coke-fueled salamanders that become damaged or unsafe to use shall be immediately extinguished and removed from the premises or, if repairable, shall be restored to a safe condition before being returned to use.
- (5) Coke-fueled salamanders shall only be used in areas with sufficient quantities of fresh air so as to maintain carbon monoxide below levels required by Federal, State and City laws, rules and regulations. **The S-92 Certificate of Fitness holder shall inspect and conduct the required monitoring in such areas not fewer than once an hour when coke salamanders are in use, to ensure that carbon monoxide levels are being maintained below such levels.**
- (6) Coke shall be stored in an approved metal bin when not being burned in a salamander. The storage bin shall be located at least ten (10) feet from any coke-fueled salamanders that are in use.



Figure 10-8. Non-combustible Metal Storage bin



Figure 10-9. Unsafe storage



Figure 10-10. Unsafe storage

- (7) Tarpaulins used to retain heat in areas in which coke-fueled salamanders are in use shall be:
  - (A) made of materials that are inherently flame-resistant or treated to be flame-resistant;
  - (B) securely fastened to prevent movement caused by the wind; and
  - (C) placed not less than ten (10) feet from any *coke-fueled salamander*.
- (8) Any areas in which coke-fueled salamanders are in use shall be adequately lighted to allow safe operation of the coke-fueled salamanders and to minimize the risk of accidental contact from construction activity on the construction site. Any electrical wiring or devices shall be installed in accordance with the Electrical Code.
- (9) Coke-fueled salamanders in use shall be inspected on a periodic basis by the certificate of fitness holder. Inspections shall be conducted as frequently as necessary to ensure the safe operation of the coke-fueled salamanders but in no circumstance less than once an hour.

### 10.5.3 Portable Fire Extinguishers

Areas in which coke-fueled salamanders are in use shall be provided with portable fire extinguishers with at least a 4-A rating for each 1000 square feet, with a maximum travel distance to an extinguisher of not more than 75 feet.

### 10.5.4 Recordkeeping

The inspection record or any corrective action taken, shall be recorded in a bound log book maintained at the construction site. The log book shall be made available for inspection by any Fire Department representative.



## **CHAPTER 11. INTERNAL-COMBUSTION-POWERED EQUIPMENT**

Internal combustion engines, whether fueled by gasoline, diesel, propane, natural gas, or other fuels, can act as ignition sources. Examples include:

- Stationary engines such as compressors, generators and pumps.
- Mobile equipment or transports such as vans, trucks, forklifts, cranes, well servicing equipment, drilling rigs, excavators, portable generators and welding trucks.
- Contractor vehicles and motorized equipment.
- Emergency response vehicles such as fire engines and ambulances.
- Vehicle-mounted engines on vacuum trucks, tanker trucks and waste haulers.
- Small portable engines such as mowers, blowers, generators, compressors, welders and pumps. This includes hand tools unrelated to a process, such as chain saws, brought in by contractors.

Internal-combustion-powered construction equipment shall be used in accordance with the following requirements:

- Equipment shall be located so that exhausts do not discharge against combustible material.
- Exhausts shall be piped to the outdoors.
- Equipment shall not be refueled while in operation.
- Fuel for equipment shall be stored in an approved area, and shall be moved in approved containers not to exceed 5 gallons.

## **CHAPTER 12. POWDER-ACTUATED TOOL LOADS**

### **12.1 Related Permit and Certificate of Fitness requirements**

FDNY permit is required to store 200 or more shells of small arms ammunition.

Powder-actuated tools shall be used only by an E-21 Certificate of Fitness holder. Powder-actuated tools shall be handled only by an E-21 Certificate of Fitness holder.

Storage of powder-actual tools shall be under the general supervision of an E-21 Certificate of Fitness holder.

The CSFSM must ensure that the FDNY permits are readily available on the construction site and the powder-actuated tools are under the supervision of E-21 Certificate of Fitness. The CSFSM also needs to ensure all applicable standards and rules are being comped with.

### **12.2 Stored, Handled and Used for Powder-Actuated Tool Loads**

Small arms ammunition shall be stored, handled and used for powder-actuated tool loads at a construction site, as follows:

- The main store of powder-actuated tool loads shall be kept in an approved locked metal box.
- The powder-actuated tool load storage box shall be kept away from heat and shall not be stored in the same storage area or storage facility containing compressed gases or flammable liquids.
- The storage area or storage facility in which the locked metal powder-actuated tool load box is stored shall bear a permanent sign bearing the words "DANGER-AMMUNITION" in 2-inch (51-mm) white letters on a red background.
- Powder-actuated tools shall not be used in an explosive atmosphere.
- The E-21 Certificate of Fitness holder shall establish a safe zone behind a work area in which powder-actuated tools are to be used by evacuating the area or placing a barrier constructed of ½ inch (12.7 mm) steel plate.
- At least one portable fire extinguisher having a minimum 2-A rating shall be provided in the area where powder-actuated tool loads are stored.
- Storage of powder-actuated tool loads shall comply with the requirements of NFPA 495. Storage shall be limited to not more than seven hundred fifty thousand powder-actuated tool loads per premises unless larger quantities are authorized by the department.

The compartment, construct shed, and/or locked metal box shall bear a permanent sign with the words "DANGER - AMMUNITION" in 2" white letters on a red background.

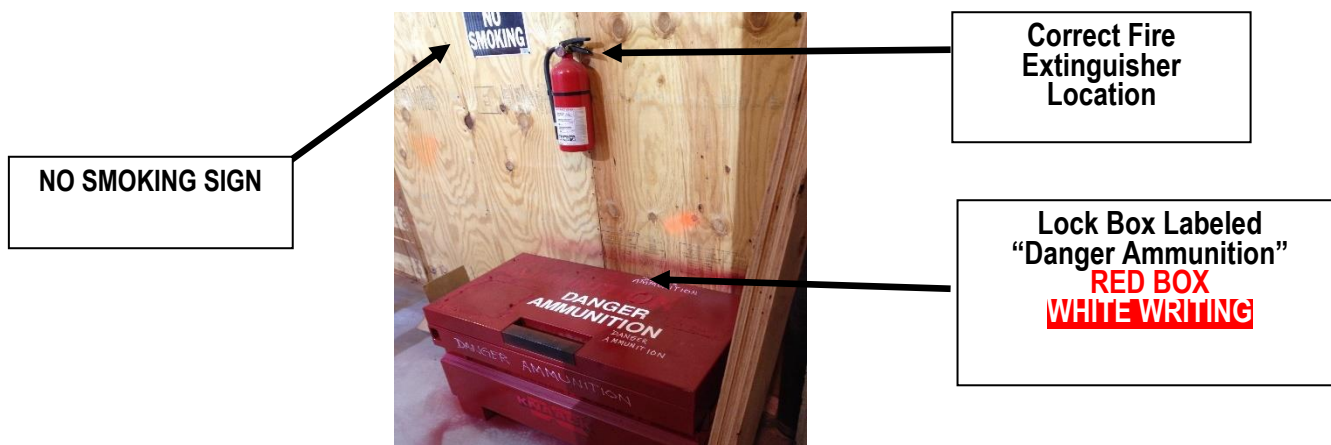

## CHAPTER 13. ASBESTOS PROJECTS

### Fire History: Deutsche Bank Fire



On August 18, 2007, a seven-alarm fire broke out on the 17th floor of the building, caused by workers smoking in violation of the building's safety rules. At the time of the fire, crews were removing asbestos. The fire spread in both directions, affecting a total of 10 floors. The floors were also filled with a maze of protective polyethylene sheets, which were designed to prevent the spread of asbestos, and also trapped smoke. The building lacked a standpipe, making it extremely difficult to put out the fire. The fire burned into the night before being extinguished, and numerous special and support units responded from the New York City Fire Department to combat the fire. The fire killed two FDNY firefighters, who succumbed on the 14th floor to smoke inhalation and carbon monoxide poisoning.

NYCDEP asbestos rule:

This rule is to protect public health and the environment by minimizing the emission of asbestos fibers into the air of the New York City when buildings or structures with asbestos-containing material are renovated, altered, repaired, or demolished by ensuring that asbestos-containing material is handled appropriately and by individuals qualified to do so.

**Negative air pressure equipment.** "Negative air pressure equipment" shall mean a portable local exhaust system equipped with HEPA filtration. The system shall be capable of creating a negative pressure differential between the outside and inside of the work area.

The following procedures shall be followed during the conduct of abatement activities on asbestos projects  
(all regulations shall be referred to Chapter 1 of Title 15 of the Rules of the City of New York

[https://www1.nyc.gov/html/gbee/downloads/pdf/dep\\_rule\\_title\\_15\\_ch.1.pdf](https://www1.nyc.gov/html/gbee/downloads/pdf/dep_rule_title_15_ch.1.pdf) ):

- All asbestos projects shall utilize negative pressure ventilation equipment.
- The negative pressure ventilation equipment shall operate continuously, 24 hours a day, from the establishment of isolation barriers through successful clearance air monitoring. If such equipment shuts off, adjacent areas shall be monitored for asbestos fibers.
- A static negative air pressure of 0.02 inches (minimum) water column shall be maintained at all times in the work place during abatement to ensure that contaminated air in the work area does not filter back to uncontaminated areas.
- If more than one ventilation unit is installed, units shall be turned on one at a time while checking the integrity of all barriers for secure attachment and the need for additional reinforcement.
- A dedicated power supply for the negative pressure ventilating units shall be utilized. The negative air equipment shall be on a ground fault circuit interrupter (GFCI) protected circuit separate from the remainder of the work area temporary power circuits.
- If the containment area of an asbestos project covers the entire floor of the affected building, or an area greater than 15,000 square feet on any given floor, the installation of a negative air cut off switch or switches shall be required at a single location outside the work place, such as inside a stairwell one floor below the lowest floor containing a work place, or at a secured location in the ground floor lobby when conditions warrant (such as when the work place is in a basement or below). The required switch or switches must be installed by a licensed electrician, pursuant to a permit issued by the Department of Buildings. If negative pressure ventilation equipment is used on multiple floors the cut off switch must be able to turn off the equipment on all floors.

A floor plan showing the areas of the building under abatement and the location of all fire exits in said areas shall be prominently posted in the building lobby or comparable location, along with a notice stating the location within the building of the negative air cutoff switch.

- Negative pressure ventilation equipment shall be exhausted to the outside of the building away from occupied areas.
- Routine smoke testing, air monitoring and daily inspections shall be performed by the Asbestos Handler Supervisor to ensure that the ducting does not release fibers into uncontaminated building areas.

When the building/structures with asbestos-containing material are renovated, altered, repaired, or demolished, the CSFSM must know the locations of the negative air cut off switch(es) and should ensure:

1. The individuals/subcontractors who perform the project have valid New York State Asbestos Certificates & Licenses.

2. DOB approval is obtained.
3. A floor plan showing the areas of the building under abatement and the location of all fire exits in said areas is prominently posted in the building lobby or comparable location, along with a notice stating the location within the building of the negative air cutoff switch.

If the project involves **one** of the following conditions:

- Disengagement or obstruction of any component of exit signage or exit lighting system.
- Disengagement of any fire alarm system component including any fire alarm-initiating device.
- Shut-off of the sprinkler system water supply.
- Shut-off of any part of a standpipe system or standpipe system components, including valves or fire pumps,

the CSFSM must ensure that the subcontractor has obtained an Asbestos Abatement Permit from the DEP before commencing abatement activities and ensure the FDNY Borough Communications Office has been notified and informed of the date and time those conditions will be created. The CSFSM must follow any instructions from the FDNY.

A Guide to the New York City Asbestos Regulations can be obtained via this link:  
[http://www.nyc.gov/html/fdny/pdf/cda/atru\\_guidance\\_document\\_final.pdf](http://www.nyc.gov/html/fdny/pdf/cda/atru_guidance_document_final.pdf)

## CHAPTER 14. AEROSOLS

### 14.1 Levels of Aerosol Products

**AEROSOLS:** Product that is dispensed by way of propellants, classified as follows:

- **Level 1:** Products with a total chemical heat of combustion that is **greater than 0 and less than or equal to 8,600** British thermal units per pound (Btu/lb).

*Typical Level 1 aerosol products include shaving cream, window cleaners, starch, rug shampoos, alkaline oven cleaners, etc.*

**Level 1** products are predominately **water-based**. Some examples are:



**Shaving Gel**



**Whipped Cream**

- **Level 2:** Products with a total chemical heat of combustion that is **greater than 8,600 but less than or equal to 13,000** Btu/lb. *Typical Level 2 aerosol products include hair sprays, deodorants, antiseptics, some furniture polishes, windshield deicers, etc.*

**Level 2** products are often **alcohol formulated based**. Some examples are:



**Hair Sprays**



**Sunscreen**



**Insect Repellents**

- **Level 3:** Products with a total chemical heat of combustion **greater than 13,000** Btu/lb.

*Typical Level 3 aerosol products include paint, lacquer, lubricants, some furniture polishes, engine cleaners, some insecticides, oil-based antiperspirants, etc.*

Examples of **Level 3** products are **hydrocarbon formulated based**:



### Carburetor Cleaner Petroleum-based Aerosols

**Special Note:**

Aerosol level **cannot** be determined by product. Some products can be categorized at multiple levels depending on BTU/lb, such as:



### Some Air Fresheners

Aerosol products in cartons must be sorted and labeled. On at least one side of the carton the following words must appear:

**LEVEL AEROSOLS**

Aerosol products in cartons that are not identified or labeled shall be classified as LEVEL 3.

**LEVEL-3 AEROSOLS**



### 14.2 FDNY Permit and Certificate of Fitness requirements

A FDNY permit is required to store, handle or use an aggregate quantity of Level 1, 2 or 3 aerosol products in excess of 100 pounds net weight.



The handling and use of aerosols in quantities requiring a permit shall be performed under the personal supervision of a person holding a W-49/A-49 Certificate of Fitness. The storage of aerosols in quantities requiring a permit shall be under the general supervision of a person holding a W-49/A-49 Certificate of Fitness.

The CSFSM must ensure that the FDNY permits are readily available on the construction site and the aerosols are under the supervision of A-49/W-49 Certificate of Fitness. The CSFSM also needs to ensure all applicable standards and rules are being complied with.

The aerosol product is stored in the containers, which, typically, labeled in net weight quantity. However, occasionally, you may find the aerosol containers to be labeled in net volume quantity (fluid ounces).



Figure 14-1. aerosol containers labeled in fluid ounces

The chart below shows the number of aerosol containers, by container capacity in net weight (oz), requiring a permit and personal supervision by a certificate of fitness holder.

<b>Permit and C of F Calculations</b>	
<b>One Can Net Weight</b>	<b>Number of Cans</b>
6 oz	267
7 oz	229
8 oz	201
10 oz	161
12 oz	134
14 oz	115
16 oz	101
20 oz	81
24 oz	67

As stated above, there may be a few occasions where aerosol product may be packed in the containers that labeled in net volume quantity (fluid ounces). A conversion factor of 10 pounds per gallon shall be used to determine the net weight of each gallon of liquid.

**100 pounds (lbs) = 10 gallons of aerosol product**

**10 gallon of aerosol product = 1280 fluid ounces (fl oz)**

(1280 fl oz.) / (?? fl oz. in can) = \_\_\_\_ cans (that reaches the quantities requiring a permit)

### **14.3 Outdoor storage requirements**

The outdoor storage of Level 2 and 3 aerosols products, including storage in temporary storage trailers, shall be separated from exposures according to the table below:

**Distance to Exposures for Outdoor Storage of Level 2 and 3 Aerosol Products**

<b>Exposure</b>	<b>Minimum distance from Aerosol Storage (feet) <sup>a</sup></b>
Public streets or private roads	20
Buildings	50
Exit discharge to a public street or private road	50
Lot lines	20
Other outdoor hazardous material storage	50

a. The minimum separation distance indicated is not required where exterior walls having a 2-hour fire-resistance rating without penetrations separate the storage from the exposure. The walls shall extend not less than 30 inches above and to the sides of Level 2 and 3 aerosol products.

## **CHAPTER 15. CRANE AERIAL FUELING OPERATIONS**

### **15.1 FDNY Permit and Certificate of Fitness requirements**

A FDNY permit is required to store, handle and use a combustible liquid (Class I liquids) such as **gasoline** in amounts exceeding **2½** gallons (9.5 L). Class II or III liquids with a flash point of 300°F or less such as **diesel** in amounts exceeding **10** gallons.

The handling and use of flammable and combustible liquids, including the dispensing of such liquids, excluding combustible liquids with a flash point over 300°F (149°C), shall be under the personal supervision of certificate of fitness holder for of flammable/combustible liquids and other hazardous chemicals or materials (S-93).

A Certificate of Fitness holder for Crane Aerial Fueling Operations (P-54) must be present at all times at a construction site when the crane aerial fueling operation is in progress.

The CSFSM must ensure that before starting a crane aerial fueling operation, the C of F holder for Crane Aerial Fueling Operations (P-54) inspects the following:

#### **A. Inspection of fueling equipment:**

- The portable tank, hose valves and all other devices and equipment used for aerial fueling is in a safe condition and ready to be used.
- Upon inspecting the fueling tank and its components, the Certificate of Fitness holder notices that the discharge hose is frayed and leaking product at its connection with the tank should discontinue the fueling operation.

**B. Weather conditions:** A reliable means should be wind speed and any approaching storms.

**C. Communication:** Radio and/or two way wireless communications should be maintained between crane operator and other personnel.

**D. Method of discharge:** The aerial fueling has to be done under gravity discharge by hoisting a portable tank to an elevation above the crane's fuel tank.

**E. Fire Source:** Check for faulty electrical fixtures, open flames or other spark producing devices. Make sure nobody is smoking around the fueling operation.

**F. Fueling of crane:** Must follow all procedures, including:

- Stopping the construction operation
- Shutting off the engine of the crane.
- The portable tank should be grounded to the crane structure

All procedures listed in the Certificate of fitness (P-54) shall be followed.

## 15.2 Temporary Portable Tank



Figure 15-1. Portable tanks for fueling crane

**Portable tank** should be designed and installed with the following requirements:

- The capacity of temporary aboveground tanks containing flammable or combustible liquids shall not exceed 660 gallons.
- the tank should be of approved steel construction and structurally strong to be repeatedly lifted for fueling.
- the lifting assembly is provided with a sufficient number of lugs capable of safely supporting the weight of the tank and the full stored fuel and allowing the tank to be maintained in a level position during lifting and fueling operations.

## 15.3 Portable Fire Extinguisher

Cranes fueled by liquid motor fuel or flammable gas shall be provided with a portable fire extinguisher with a minimum 10-B:C rating located either in the crane's cab or in its immediate vicinity.

## **CHAPTER 16. Recordkeeping and CHECKLIST**

The CSFSM shall conduct an inspection of the construction site and all fire safety measures on at least a daily basis, and maintain a record of same in a bound log book or other approved system of recordkeeping. The CSFSM is responsible to ensure that every required record of all fire safety-related activities is maintained on the construction site and must be made available for inspection for Fire Department.

## 16.1 Construction Site Fire Safety Manager Daily Report

Construction Site Fire Safety Manager Daily Report		
GENERAL INFORMATION		
Job Number: _____	Job Name: _____	Date: _____
Today's man count: _____	Workers oriented and fire safety trained; documentation up to date and on file: today _____ total _____	
Describe any negative air/asbestos/infectious disease controls in use: _____		
FDNY COMMUNICATIONS AND INSPECTIONS		
FDNY Gang Box	<input type="checkbox"/> Painted red, stenciled with "FDNY" in white, and secured in place at site entrance? <input type="checkbox"/> Contents are up to date?	
	<input type="checkbox"/> Emergency contact numbers (attached to underside of cover; should include all subcontractor contacts)? <input type="checkbox"/> Copies of all FDNY permits? <input type="checkbox"/> Comprehensive floor plans for each floor- no hand-drawn modifications or annotations-with updated and accurate egress marked, "you are here" indication, and all access routes to interior stairs marked? <input type="checkbox"/> Sprinkler shop drawings for standpipe (basement and risers only)? <input type="checkbox"/> Logistics plan indicating locations of OS&Y valve and standpipe, guard booths, gas storage areas, hoists? <input type="checkbox"/> Evacuation plan and muster point location map or list?	
FDNY Inspector	Date of last FDNY inspection: _____ If today: Inspector's Name: _____ Inspector's Signature: _____ Inspector's Department/FDNY Company: _____ Notes/violations issued: _____	
<input type="checkbox"/> Yellow line painted on grade leading to the staircase containing the standpipe and/or fire pump?		
FIRE SAFETY INSPECTIONS		EVACUATION DRILLS
<input type="checkbox"/> Access and egress paths visually inspected and properly maintained. Date of last weekly shanty inspection: _____ <i>Fire Extinguishers- verify placement daily; inspect and initial tag monthly</i> <input type="checkbox"/> Tagged and in place at each shanty? <input type="checkbox"/> Tagged and in place on all floors and at areas of high fire risk work? <input type="checkbox"/> Inspected and tags initialed? Date of last inspection: _____		Date of last quarterly drill: _____ If today: Start time: _____ End time: _____ Number of workers evacuated: _____
HOTWORK AUTHORIZATION AND HOT WORK LOG MAINTENANCE		
<input type="checkbox"/> Hot works authorization and log books issued at beginning of day signed off by CSFSM at end of day?		<input type="checkbox"/> FDNY permits up to date?
NO-SMOKING ENFORCEMENT		
<input type="checkbox"/> FDNY no smoking signage posted on floors and at site gates?		
<input type="checkbox"/> Designated off-site smoking area clear of debris? Proper disposal receptacles in place outside of fence?		
Number of undercover security guards on site (need one per 200 workers): _____ Number of cigarette butts found: _____		
Name and company of any worker dismissed for violating no smoking policy: _____		
_____ Number to date: _____		
ELECTRICAL COMPONENTS AND SYSTEMS		
<input type="checkbox"/> Temporary wiring for electrical power and lighting installations visually inspected and properly maintained. <input type="checkbox"/> No visually damaged electrical cords or cables.		
HAZARDOUS MATERIALS (IF APPLICABLE)		
<input type="checkbox"/> Required FDNY permits and COFs for the storage and use of flammable (acetylene, LPG or CNG) and/oxygen gases.		
<input type="checkbox"/> Required FDNY permits and COFs for the storage and use of flammable and combustible liquids.		
<input type="checkbox"/> Required FDNY permits and COFs for powder-actuated tool loads.		
<input type="checkbox"/> Required FDNY permits and COFs for aerosols.		
<input type="checkbox"/> The hazardous materials are only used and stored at the permitted place.		
WATCHPERSON UPDATE		
<input type="checkbox"/> The watchperson(s) has been updated with the most recent site changes.		

Revised on 07/2023 (update the NOE-COIB)

STANDPIPE DAILY INSPECTION (C: compliance; NC: Noncompliance)					
STANDPIPE STATUS					
<input type="checkbox"/> Dry <input type="checkbox"/> Wet		<input type="checkbox"/> Standpipes inspected visually in their entirety, from the tops to the Siamese connections on street level; covered sections traced using schematic diagrams.			
DAILY INSPECTION		C	N/A	NC	IF NC, INDICATE CORRECTIVE ACTION TAKEN
D1	OS&Y valves chained and locked in the open position				
D1	No visible signs of damage to horizontal/vertical pipe				
D2	No visible signs of damage at pipe couplings				
D3	Sections of pipe are visible				
D4	Sections of pipe are painted red				
D5	No visible signs of damage at all hose connections				
D6	Correct caps at hose connections in stairways				
D7	Correct caps at FDNY connections				
D8	Valve handles are intact in stairways				
D9	No indications of air or water leakage along system				
D10	No visible signs of damage to alarm wiring or conduit				
D11	No material blocking access to hose connections				
D12	Functional red lights at FDNY connection locations on sidewalk bridge				
D13	No obstructions at fire hydrants				
D14	No visible signs of damage to air compressor				
D15	Compressor air pressure reading	PSI		Time of reading:	
Pressurized Air Standpipes with Alarms <input type="checkbox"/> None <input type="checkbox"/> Pressurizing mechanisms and alarm visually inspected? Pressurized from floor _____ to _____ Date of last weekly pressure alarm test: _____ If any alarm incidents, indicate cause and response taken: _____		<input type="checkbox"/> Standpipes Under Water Pressure Standpipes Under Water Pressure <input type="checkbox"/> DOB/FDNY paperwork Entity that controls the standpipe: Wet from floor _____ to _____ <input type="checkbox"/> Contractor's current certification of standpipe readiness on file? If any alarm incidents, indicate cause and response taken: _____			
For any air or hydrostatic pressure test of a standpipe performed today: Location tested: _____ Contractor performing test: _____ Contractor Witness: _____ Witness: _____					
COMMENTS					
_____ _____					
CONSTRUCTION SITE FIRE SAFETY MANAGER					
Name: _____		Signature: _____		Date: _____	

Note: The CSFSM shall document the installation of the alarm, any incidents in which it sounds, and any steps taken in response to any alarm. All alarm activations, inspections, and repairs shall be logged into the log book maintained by the CSFSM.



## 16.2 Watchperson Daily Record

The watchperson document any incidents and conditions he/she noticed during the shift. The sample form is provided below.

### WATCHPERSON RECORD FORM (example)

Construction Site Address/ Location <hr style="width: 80%; margin: 10px auto;"/> <hr style="width: 80%; margin: 10px auto;"/>
--

Directions:

- As the watchperson, you are required to make hourly inspections, and to record the result of your inspections on this log.
- Write “Yes” for items that are satisfactory. If not, explain.
- Provide a description of unsatisfactory items in the comments section and bring them to the attention of the responsible person.

<b>Date</b>						
<b>Watchperson’s name</b>						
<b>Watchperson’s COF #</b>						
<b>Watchperson’s signature</b>						
<b>Shift start time</b>	__:__	__:__	__:__	__:__	__:__	__:__
<b>Shift end time</b>	__:__	__:__	__:__	__:__	__:__	__:__
<b>Fire extinguisher availability:</b> Is any fire extinguisher accessible to the watchperson?						
<b>Secured opening:</b> Is every opening on street level secured?						
<b>Fire Department Connection:</b> The connection is visible, sign is placed correctly, the red light is functional						
<b>Air pressurized alarm system:</b> Everything is in place and functional. No alarm went off.						
<b>First responder box:</b> The box is in place.						
<b>Note for any incident</b>						

### 16.3 Standpipe Weekly Inspection and Hydrostatic Test Record

#### Standpipe System Testing and Inspection Report (C: compliance; NC: Noncompliance)

DATE

STANDPIPE STATUS	INSPECTION TYPE
<input type="checkbox"/> <i>Dry</i> <input type="checkbox"/> <i>Wet</i>	<input type="checkbox"/> <i>Weekly</i> <input type="checkbox"/> <i>Hydrostatic Test</i>

WEEKLY INSPECTION AND TESTING		C	N/A	N/C	IF NC , INDICATE CORRECTIVE ACTION TAKEN
W1	Fire Hose Valve is operable ‡				
W2	Air Drying Unit/Heat Tracing is functional				
W3	Identification Signage/Labeling is posted				
W4	Alarm back-up power device is functional				
W5	Compressor Alarm Test				Time at valve opening: _____ Pressure: <i>when alarm sounds</i> _____ PSI <i>when compressor starts</i> _____ PSI <i>when compressor stops</i> _____ PSI

WHEN REQUIRED	
H1	Hydrostatic Test      _____ PSI      Time of reading: _____

INSPECTOR
Name: _____      Signature: _____ re: _____

‡ Test a random sampling amounting to at least 5% of the total installation.

## **16.4 Fire Watch for Impairment Record**

**The record must be maintained for at least 48 hours after the fire watch has finished.**

The daily written record must be signed by the fire guard. The following items must be logged:

- (a) the number of inspections completed;
- (b) defects found;
- (c) violations that have been found, and
- (d) the date, name, Certificate of Fitness number and signature of the fire guard who conducted the inspections.

An example of the inspection record is shown as below.

Fire Watch/Fire Guard Daily Record (example)

Building Address: _____ _____ Patrolled Area: _____
--

**Fire Watch/  
Fire Guard Record**

Date: _____ C of F Holder's Name: _____ _____ Signature: _____ C of F # : _____ Exp Date: _____
--

Directions:

- As the Fire Guard, you are required to make hourly inspections, and to record the result of your inspections on this log.
- Put “OK” for items that are satisfactory, “X” for items that are unsatisfactory, and “N/A” for items that are not applicable.
- Provide a description of unsatisfactory items in the comments section and bring them to the attention of the responsible person.
- Print your name and sign the log at the end of your shift.

<b>Time</b>	__:	__:	__:	__:	__:	__:
<b>Exits and stairways:</b> Ensure exits and stairways are not blocked. Exit doors/gates are free of locks. Self-closing doors are not open. There is a lot of lighting in exit corridors.						
<b>Potential Ignition Sources:</b> Look for arcing or exposed electrical wiring.						
<b>Trash Accumulation:</b> Ensure that corridors are free of debris and rubbish.						
<b>No-Smoking:</b> Ensure “No Smoking” is enforced in the affected areas.						
<b>Fire Alarm Pull Stations:</b> Should be inspected for damage.						
<b>Fire Extinguisher:</b> Fire extinguishers should be in their designated areas.						
<b>Standpipe and Sprinkler System:</b> Inspect for breaks, leaks and damage. Ensure that there is no blockade in the FDNY connections and fire hydrants.						
<b>Comments</b>						

## 16.5 Hot-work Record

A fire watch must be maintained during any hot work operation. The fire watch must continue for a minimum of 30 minutes after the conclusion of the work. The FDNY, or the responsible person implementing a hot work program, may extend the duration of the fire watch based on the hazards or work being performed.

However, if you use CNG or LPG for torch operation, **the first inspection shall be conducted 30 minutes after completion of LPG/CNG torch operations; the second inspection 1 hour after completion of LPG/CNG torch operations.** This is to make sure that there are no smoldering fires in the building. The fire guards must complete a signed inspection report. The fire guards or fire watch personnel must complete a signed inspection report (or the log book).

**This report must be submitted to and retained by the person in charge of the torch operations.** The inspection report must be made available to any representative of the Fire Department and should be maintained on the premises for reasonable length of time (e.g. 48 hours) after work is complete.

Example: Fire Guard Daily Log Book for Hot Work

**Fire Guard’s Daily Log for Hot Work**

Date: \_\_\_\_\_

- Each fire guard monitoring hot work must complete this log daily
- Enter a check for each item after verifying it for compliance in each active hot work area. If an item is not compliant and the competent person designated for this hot work operation or the fire guard cannot correct it, then no hot work may proceed in the area and must be notified.
- Notify personnel of any and all incidents that occur. Fires of all sizes must be reported, even if they are immediately extinguished. If a fire cannot be extinguished immediately, contact emergency services (e.g. 911) directly.
- Report any fires related to hot work operations in the comments section of this log.
- Print your name and sign this log at the end of your shift.

<i>Before beginning and while performing hot work</i>							<i>After completing hot work</i>
WORK AREA	Hot work authorization	INCIDENT REPORTING	FIRE EXTINGUISHER	COMBUSTIBLES	FLAMMABLES	FIRE GUARD	POST-WORK CHECK
List each active hot work area on the lines below.	Posted by fire guard at work area?	Radio or phone on hand to notify personnel in case of incident?	At least a 2-A:20-B:C rating fire extinguisher in work area? (a minimum 3-A:40-B:C rating fire extinguisher on torch-applied roofing system operations?)	Wood, cardboard, & other combustibles within 35’ to work area? Blankets protecting gas bottles in use?	Gas, Fuel, and other flammables no closer than 35’ to work area?	Fire guard has an unobstructed line of sight?	Area checked 30 minutes after completion of work?
COMMENTS							

**Name:** \_\_\_\_\_

**Signature:** \_\_\_\_\_

Revised on 07/2023 (update the NOE-COIB)

**Fire Guard Certificate of Fitness Number:** \_\_\_\_\_ **Expiration**  
**Date:** \_\_\_\_\_





Revised on 07/2023 (update the NOE-COIB)

b. Heaters must be electric, ceiling mounted, equipped with a protective cage, and wired by an electrician. Floor heaters must be of the oil-filled type. Cords must be replaced and not repaired if damaged.

## 16.7 Project CSFSM Initiatives-Monthly Self-Assessment Form

Project Name			Date			
Category	Item	Response		Recommended Action		
<b>G E N E R A L  R E Q U I R E M E N T S</b>	What type of space heater is being used?	<input type="checkbox"/> Coke <input type="checkbox"/> Kerosene <input type="checkbox"/> LPG <input type="checkbox"/> CNG <input type="checkbox"/> Piped natural gas <input type="checkbox"/> Electric				
	How many heaters are in use?	Quantity:				
	In what locations are heaters in use?	Locations:				
	What subcontractor is supervising temporary heat operations?	Subcontractor Name:				
	Valid S-92 FDNY C of F holder for portable fueled space heaters supervising operation?	Yes	No	If no, discontinue use remove from site, and obtain permit		
	Is there a FDNY permit for portable heater storage and use?	Yes	No	If no, discontinue use remove from site, and obtain permit		
	Are carbon monoxide readings recorded every hour if utilizing coke heaters?	Yes	No	If no, correct and comply.		
	Is there a copy of the manufacturer's operating and maintenance instructions on site for the heaters?	Yes	No	If no, correct and comply.		
	If the building is 75 ft in height, is the standpipe system operating according to code requirements?	Yes	No	If no, correct and comply.		
	If the building is 75 ft in height, is the elevator in readiness?	Yes	No	If no, correct and comply.		
	How many extinguishers are required for each floor?	Amount Required:				
	Are fire extinguishers properly placed and easily accessible? (not more than 30' away from each heater)	Yes	No	If no, correct and comply.		
	Is there a log book available for S-92 entries?	Yes	No	If no, correct and comply.		
	Has adequate temporary lighting been installed on the heated floor(s)?	Yes	No	If no, correct and comply.		
	Heaters are maintained the proper 10 feet away from combustibles?	Yes	No	If no, correct and comply.		
	Is proper signage posted? (No Smoking, Flammable Liquid Storage, LPG Storage, etc.)	Yes	No	If no, correct and comply.		
Are tarps being used rated properly?	Yes	No	If no, correct and comply.			
Are tarps properly secured?	Yes	No	If no, correct and comply.			
Are heaters at least 10 feet away from all tarps?	Yes	No	If no, correct and comply.			
<b>S O L I D  F U E L  C O K E</b>	Has a FDNY variance been acquired if utilizing solid fueled coke salamanders?	Yes	No	If no, discontinue use, remove from site, and obtain variance		
	Is there adequate ventilation in place in order to avoid gas build up?	Yes	No	If no, correct and comply.		
	How many S-92 FDNY C of F holders are required? (coke only; 1 C of F/50 heaters)	Amount Required:				
	Is there an escape hatch in place as required?	Yes	No	If no, correct and comply.		
	Are there fire extinguishers every 1000 square feet on floors where coke heaters are in use?	Yes	No	If no, correct and comply.		
	Is the LPG torch used to ignite coke being operated personally by the S-92 Certificate holder?	Yes	No	If no, discontinue use of LPG torch		
<b>E l e c t r i c</b>	All coke salamanders are on noncombustible platforms	Yes	No	If no, correct and comply.		
	Are metal bins being used to store solid fuel onsite?	Yes	No	If no, provide metal bins for proper storage.		
<b>K e r o s e n e</b>	Are electric heaters with glowing red elements in use?	Yes	No	If yes, remove and replace with acceptable heater		
	Are all electric heaters (except oil-filled radiator type) hardwired?	Yes	No	If no, hardwire all heaters to correct		
	Is there a FDNY permit for storage of kerosene? (required when quantity onsite exceeds 10 gallons)	Yes	No	If no, discontinue use, remove from site, and obtain permit		
<b>E l e c t r i c</b>	Are only approved (metal with spout and self-closing cap) 5 gallon portable cans being used to refuel?	Yes	No	If no, obtain proper portable metal safety cans		
	Are proper kerosene storage control areas maintained? (240 gal per area max if in safety cabinet)	Yes	No	If no, correct and comply.		
	Is the building occupied?	Yes	No	If yes, LPG salamanders are not prohibited for use		

<b>L P G</b>	Is there a FDNY permit storage of LPG?(required when quantity onsite exceeds 400 SCF/47 lbs)	Yes	No	If no, discontinue use, remove from site, and obtain permit
	Are LPG cylinders are transported using a proper hand truck?	Yes	No	If no, obtain the proper hand truck for correct handling
	Are all LPG cylinders in storage and use above grade level?	Yes	No	If no relocated above grade level
	Is there more than 2,500 pounds of LPG in one storage area?	Yes	No	If yes, separate LPG as necessary to comply
	Is the total capacity of LPG stored and in use onsite more than 5,000 pounds?	Yes	No	If yes, remove LPG from site so total qty is less than 5,000lbs
	LPG storage locations are separated by 50 Ft from combustibles and other LPG storage locations?	Yes	No	If no, correct and comply
<b>Natural Gas</b>	Is there a FDNY permit for storage of CNG if natural gas is not piped? (required if qty exceeds 400 SCF/47 lbs)	Yes	No	If no, discontinue use, remove from site, and obtain permit
	Is there a quarter turn shut-off valve for each natural gas pipe outlet where heaters are connected?	Yes	No	If no, correct and comply.
	Are there more than 4 heaters connected to any one shut off valve?	Yes	No	If yes, reduce the number to 4 or less per shut-off valve
	Are any flexible hoses longer than 20 feet	Yes	No	If yes, reduce the length to 20 ft or less
<b>End of Shift Inspection</b>	Will heating operations continue after the end of the normal (0800-1600) workday?	Yes	No	If yes, answer next question
	Is there an S-92 C of F holder on site to provide supervision so heating may continue?	Yes	No	If no, discontinue heating operation
<b>S-92 COF Holder Shift 1</b>	<b>Signature</b>			<b>Date</b>
	<b>Name</b>			
<b>S-92 COF Holder Shift 2</b>	<b>Signature</b>			<b>Date</b>
	<b>Name</b>			

## **16.8 CDA Walkthroughs**

The Construction Demolition and Abatement Unit (CDA) is a unit within the Bureau of Fire Prevention that is responsible for inspecting buildings under construction, demolition, or abatement.

The Construction Demolition and Abatement Unit have broad authority to inspect fire and life safety conditions on construction sites, including provisions of both the Fire Code and Building Code.

*The CSFSM should meet the Construction Demolition and Abatement Unit (CDA) inspector at site gate.*

FDNY Operations will also be conducting site familiarization drills every 30-90 days depending on the size of the building. These drills are designed to give first arriving units to a fire or emergency some familiarity to the site and are typically scheduled prior to the event, but not always. While the main reason for their visit is familiarize themselves with the status of construction and fire protection system (especially the standpipe system and FDNY connections), these units can take enforcement action and or request the response of CDA unit or DOB Construction Safety Unit

### **Typical items inspected, but not limited to, during the Construction Demolition and Abatement (CDA) walkthrough are:**

They will want to see the following materials including but not limited to:

- Posted Department of Buildings Permit & Variance(s)
- Fire Department Permit & Variance(s) and Hot Work Authorization
- S-56 and all job-related Certificates of Fitness
- Site Safety Manager's license
- logbooks or other approved form of recordkeeping documenting the inspection or test or activities addressed in this chapter
- Pre-Fire Plan and Emergency Evacuation Procedure
- Required signage (e.g. no-smoking sign, exit sign, etc.) posted
- Site contact information (general contractor and owner)
- Standpipe system and Fire Department connections
  - Air-pressurized alarm system
  - Clear access
  - Proper signage
  - Red light

# 16.9 CDA Checklist



## Fire Prevention Construction, Demolition and Abatement Unit Building Information Form

CDA-1 (10-09)

Division: \_\_\_\_\_ Date: \_\_\_\_\_ Name of CDA Inspector: \_\_\_\_\_

BIN: \_\_\_\_\_ Building Address: \_\_\_\_\_

Contractor Name: \_\_\_\_\_

Building Height (ft): \_\_\_\_\_ Floors: \_\_\_\_\_ Dimensions (ft): \_\_\_\_\_ x \_\_\_\_\_ Inspection Class  
 CDA 30 Day  CDA VO  
Re-inspection

**Occupancy Classification:**  Assembly: Group A  Business: Group B  Educational: Group E  
 Factory/Industrial: Group F  High Hazard: Group H  Institutional: Group I  
 Mercantile: Group M  Residential: Group R  Storage: Group S  Utility/Miscellaneous: Group U

**Inspection Time:** Hrs \_\_\_\_\_ Mins \_\_\_\_\_

Standpipe System:  Yes  No Siamese connection(s) \_\_\_\_\_ Location(s) \_\_\_\_\_

Stairways Identified: Yes  No  Location of risers: Stairway(s) \_\_\_\_\_ Elevators Identified:  Yes  No

Does the dry standpipe system have an air pressurized alarm system?  Yes  No  
Is there a working air gauge on the alarm system?  Yes  No  
If no, was the entire standpipe system traced from siamese connections to uppermost standpipe cap?  Yes  No

**Enforcement Action Taken:**

NOV(s) Issued: \_\_\_\_\_ VOs: Issued \_\_\_\_\_ Complied With \_\_\_\_\_ A8 Referrals \_\_\_\_\_ Summons: \_\_\_\_\_  
qty qty qty qty qty

Summon #(s)

NOV / VO#(s)

**Building Status:**  Active Site  No Access

- No Activity / Vacant Lot (construction has not commenced at site)
- Excavation / Foundation
- Construction Suspended: Stop Work Order / Labor Issue / Financing / other: \_\_\_\_\_

Major Construction Completed / No Further Inspection Required

(All of the following must be present to be deemed Major Construction Completed)

- Required elevators complete and operational.  All interior stairway(s) completed.  Required standpipe(s) is completed and operational.  Required sprinkler system is complete and operational.  Exterior elevators and hoists have been removed and exterior skin of building is closed up.  Site Safety Manager no longer required under prevailing law and regulation and sidewalk shed has been removed.  All structural welding completed.

Remarks: \_\_\_\_\_

Supervisor: \_\_\_\_\_ Date Reviewed: \_\_\_\_\_ Submitter: \_\_\_\_\_ Date Entered: \_\_\_\_\_

## CHAPTER 17. FIRE AND EMERGENCY PROCEDURES

### 17.1 First Responder Box

The FDNY may require that a First Responder Box be provided at a construction site for first responder use. The CDA unit and/or the Local Fire House will decide its necessity based on size and complexity of the construction site.



Where the First Responder Box becomes necessary, the First Responder Box should contain building access keys, the Pre-Fire Plan, and other documents required by the Fire Code. Such box must be in an approved location and, if locked, must be openable by use of a citywide standard key and a Fire Department standard key.

The purpose is to consolidate important documents and information into one location. It enables the CSFSM to store important information into one location. It can be used for the regular training and will assist firefighting personnel responding to a fire or other emergency at the construction site.

Exact location of the First Responder Box should be determined in coordination with FDNY. All construction site workers should know the location of the First Responder Box. The CSFSM should also ensure the box is located on a solid surface with clean surroundings and it is easily accessible 24/7.

#### Recommend appearance of the First Responder Box:

- Painted red gang box
- “FDNY” neatly & clearly written with reflective tape (top, front & both sides)
- Internal compartments to properly organize binders and drawings
- *The top of the box should be cleared of all materials (construction materials, snow, ice, etc) and not used as a table or cutting station*
- *Depending on the size of the construction site, more than 1 responder box may be required.*
- *The box should protected from weather to the degree that it doesn't freeze closed.*

Figure 17-1. First responder box (outside)	Figure 17-2. First responder box (inside)
	

The following content is a list of recommended document or material that may be asked by the FDNY firefighters, but the final content of each First Responder Box should be discussed with the Local Fire House.

**Recommended contents in the First Response Box:**

■ **Emergency Contact List – Job Specific**

- Attached to underside of lid
- Laminated
- The list must have the following phone numbers:
  - a. Police
  - b. FDNY
    - For all emergencies call 9-1-1
    - FDNY Borough Dispatcher # for fire protection system impairment
      - Manhattan 212-570-4300
      - Bronx 718-430-0200
      - Brooklyn 718-965-8300
      - Queens 718-476-6200
      - Staten Island 718-494-4296
  - c. DOB Construction Safety Unit
  - d. Ambulance or nearby hospital contact number
  - e. Company Main Office

■ **Work, home, and mobile numbers of the following:**

- Senior Superintendent
- Site Safety Manager
- Construction Site Fire Safety Manager
- Senior Project Manager
- Company Fire Safety Manager
- Hoist Subcontractor Contact
- Security Subcontractor Contact
- Fire Suppression Contact
- Elevator Subcontractor Contact
- Electrical Subcontractor Contact
- Crane Subcontractor Contact

■ **Egress and access**

■ **Floor by Floor Egress Plans**

- Clearly marked as “Floor by Floor Egress Plans”
- Laminated, bound together
- Clearly labeling entry and exit points

■ **Updated Standpipe Diagram**

- Clearly indicating highest floor served by standpipe (updated as necessary)

- Full Size
- Laminated
- Labeled as “Current Standpipe Diagram”

■ **Site Safety Plan illustrating the following:**

- Full Size
- Laminated
- Labeled as “Site Safety Plan”
- The Site Safety plan must clearly identify “You Are Here” and illustrate the following:
  - a. Locations of standpipe(s), gas storage, fuel storage, hoists
  - b. Crane locations
  - c. Evacuation procedure
  - d. Muster points
  - e. Location of OS & Y valve

■ **Access keys for any lock (storage cabinets, OS&Y valve, etc.) used within the construction site.**

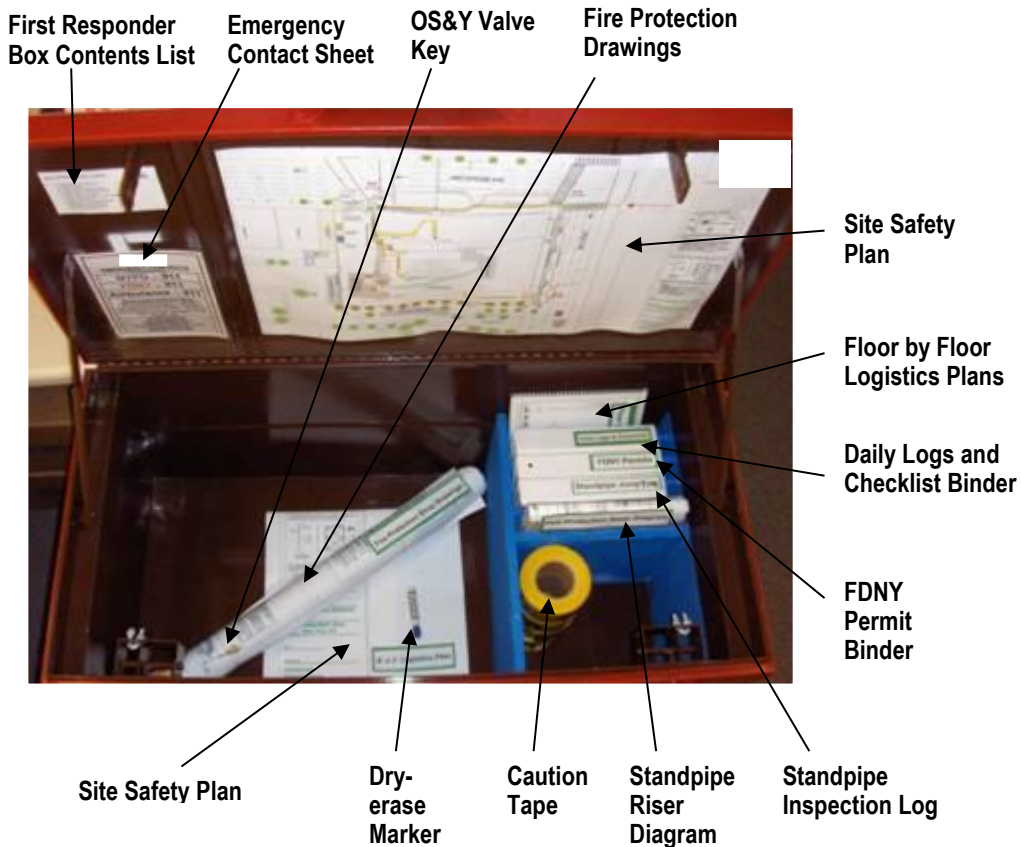

Figure 17-3. Sample contents inside First Responder Box



## 17.2 Local Fire House Site Visits

Local Fire House Liaison and FDNY Local Fire House should be invited to tour each jobsite once monthly and/or after any major logistics change within or around the jobsite.

Any visits are to be documented in the CSFSM Daily Report, which is to be signed by the visiting senior member and kept in the FDNY First Responders' Box.

Contact the Borough Dispatch listed below for non-emergency calls (i.e. impairment, negative air in use, etc.) and when taking systems out of service (i.e. standpipe, sprinklers, demo, etc.). All calls to Borough Dispatch will be recorded.

Manhattan	(212) 570-4300
Brooklyn	(718) 965-8300
Queens	(718) 476-6200
Bronx	(718) 430-0200
Staten Island	(718) 494-4296

## 17.3 Access for Firefighting

Approved vehicle access for fire apparatus shall be provided to all construction sites. Vehicle access shall be provided to within 100 feet of temporary or permanent fire department connections. Vehicle access shall be provided by either temporary or permanent roads, capable of supporting vehicle loading under all weather conditions. Vehicle access shall be maintained until permanent fire apparatus access roads are available.

**Key boxes.** Where access to or within the construction site is restricted because of locked doors or other building openings, or where immediate access would be needed for lifesaving or firefighting purposes in the event of a fire or other emergency, the Fire Department may require that keys be kept in a key box installed in an approved location. The owner shall ensure that the key kept in the lock box is replaced whenever a lock securing the area, box or cabinet is changed or rekeyed.

## 17.4 Notification Contact Numbers

- For **all** emergencies **call 9-1-1**
- FDNY Borough Dispatcher # for fire protection system impairment

Manhattan	212-570-4300
Bronx	718-430-0200
Brooklyn	718-965-8300
Queens	718-476-6200
Staten Island	718-494-4296

- *You should have the work, home and mobile numbers of the following individuals readily available:*
  - *Senior Superintendent*
  - *Site Safety Manager*
  - *Construction Site Fire Safety Manager*
  - *Senior Project Manager/ Project Executive*
  - *Hoist Subcontractor Contact*
  - *Security Subcontractor Contact*
  - *Master Fire Suppression Contractor and Master Plumber Contact*
  - *Elevator Subcontractor Contact*
  - *Electrical Subcontractor Contact*
  - *Crane Subcontractor Contact*
- *Post this list in the following locations, if applicable:*
  - *Guard Shack*
  - *Superintendents' Office*
  - *Project Management Office*
  - *Underside Lid of FDNY First Responders' Box*
  - *As the first page in the Daily Log and Checklist binder within the FDNY First Responder's Box*
- *Additional contact number guidelines:*
  - *Be sure the construction site workers understand the numbers are for emergency use only.*
  - *Do not display contact numbers in a location visible to the public or general job site population.*
  - *This emergency contact procedure is a vibrant illustration; however, yours can be in a simple table format establishing the same efficient communication route to these key individuals/organizations.*

## **17.5 Automatic air pressurized alarm activation**

The alarm shall be automatically activated when the pressure drops below the supervisory pressure or rises above the maximum pressure of 25 psig.

**When the alarm is activated when the CSFSM is not present, the watchperson or other construction site personnel must call 911.**

**When the alarm is activated when the CSFSM is present, the CSFSM shall:**

- (1) Immediately notify the Fire Department that the alarm is activated and explain nature of call (if available).
- (2) All work at the site shall cease.

**Exception:** the activation of the alarm shall not require the cessation of work necessary for the completion of concrete pouring operations in progress at the time of alarm activation, where such cessation would cause a cold joint that would impair the structural integrity of the finished construction. The continuation of such operations shall be permitted only until an orderly termination of such operations can be effectuated. The site safety manager or coordinator shall record the names and locations of any employees necessary for the completion of the concrete pouring operations and provide them to the Fire Department personnel who arrive on the scene.

- (3) Contact the Licensed plumber or master fire suppression contractor to perform an investigation of the entire standpipe system and air compressor shall be immediately performed to determine the cause of the alarm. Unless authorized by the Fire Department, no construction or demolition work shall resume until the standpipe system is repaired and the appropriate pressure is restored, except that any repairs to the standpipe system needed to restore the required pressure shall be undertaken immediately and the standpipe system restored as soon as possible.
- (4) Implement the out-of-service procedures before the system restored (refer to Section 4.5 of this booklet)

Upon completion of repairs to the standpipe system a full inspection of such system shall be performed which shall include:

- (1) visually tracing the standpipe, including risers, cross connections and fire department connections to verify that no breach exists
- (2) checking all gauges of the standpipe system to ensure the standpipe system has been restored to a state of readiness.

Be sure to notify FDNY when the corrective work is complete.

Where a site safety manager or coordinator is required, all alarm activations, inspections, and repairs shall be logged into the log book maintained by such site safety manager or coordinator.

If the standpipe system is not returned to a state of readiness and the alarm reactivated within 2 hours of such planned removal from service, all construction or demolition work at the site shall cease.

All events in the Daily Standpipe Inspection Log and the FDNY/CSFSM Daily Report.

## 17.6 Emergency Notification

Ensure all construction site workers are trained and knowledgeable about the emergency notification procedures.

### 17.6.1 Emergency telephone

A telephone not requiring a coin to operate, or other approved clearly identified means to notify the Fire Department, shall be provided at an approved location. The street address of the construction site and the emergency telephone number of the fire department shall be posted adjacent to the telephone or other approved device. The street address posted by the telephone should be identical to the address posted outside the construction site.

### 17.6.2 Emergency notification procedures

Any person becoming aware of any fire (even the fire has been extinguished) or other emergency at a construction site he/she must immediately telephone 911 and report the emergency. There should be no delays in making such notification. The person should also immediately notify the Construction Site Fire Safety Manager of the emergency, but **only after telephoning 911**.

All construction site workers must know the location of the emergency telephone and must have immediate access to it. The workers can also use a wireless phone to make emergency notifications. **Notifying the FDNY by phone is the most direct and effective way to make notification of an emergency.**

*The information that may be required when calling 911:*

When notifying 911 of a fire or other emergency, the call-taker will need to obtain certain information about the emergency. Obviously the nature of the emergency and address are the most critical pieces of information. The address should be identical to the address posted outside the construction site. The operator may also ask what the nearest cross-street is, and if anyone is in need of medical attention and if so, what are their symptoms.

Additionally, if it is a very large construction site, it is likely that there will be more than one means of entry. Providing information about which entrance would provide the most direct access to the emergency area would be helpful in getting the emergency response personnel to the area of the emergency as quickly as possible. If certain construction site entrances are obstructed with construction equipment or construction materials and are not easily accessible by emergency responders this information should be communicated to the 911 operator. The more information the caller has available to communicate to the 911 operator, the more efficient they can get the right kind of help to the site quickly.

When any person calls 911, in addition to the information mentioned above, the caller should be prepared to answer other 911 operator questions, which may include:

- The phone number you are calling from
- The nature of the emergency
- Details about the emergency, such as a physical description of a person who may have committed a crime, a description of any fire that may be burning, or a description of injuries or symptoms being experienced by a person having a medical emergency

Be prepared to follow any instructions the operator gives. Many 911 operators can tell the caller exactly what to do to help in an emergency until help arrives.

Finally, do not hang up until the operator instructs to do so.

### 17.6.3 Prepare for the FDNY first responders and interaction

Before the FDNY arrives, the CSFSM should put the Pre-Fire Plan into action, contact the Senior Superintendent and confirm all head counts ASAP. During a major fire or emergency at a construction site, determining an accurate head count will be a primary concern of responding FDNY units.

After the FDNY arrives, the CSFSM or other responsible person designated by the CSFSM should be sure to meet the emergency responders to provide them with information regarding the nature of the emergency, its location on the construction site, hazardous material information (what materials are present onsite), hot work operation activities and to provide any additional information that the emergency responders request.

The material/document that the FDNY first responders may ask for should be saved in the First Responder Box. If there is no First Responder Box required on site, the FDNY highly recommends that the CSFSM should prepare a “First Responder Kit” containing the following materials/documents. The CSFSM and other responsible person (e.g. watchperson) should be familiar with the location of this kit so they can provide it to the arriving first responders upon their request.

The recommend materials/documents including but not limited to:

- **Work, home, and mobile numbers of the following:**
  - Senior Superintendent
  - Site Safety Manager
  - Construction Site Fire Safety Manager
  - Senior Project Manager
  - Company Fire Safety Manager
  - Hoist Subcontractor Contact

- Security Subcontractor Contact
  - Fire Suppression Contact
  - Elevator Subcontractor Contact
  - Electrical Subcontractor Contact
  - Crane Subcontractor Contact
- **Egress and access**
- **Floor by Floor Egress Plans**
- Clearly marked as “Floor by Floor Egress Plans”
  - Clearly labeling entry and exit points
- **Updated Standpipe Diagram**
- Labeled as “Current Standpipe Diagram”
  - Clearly indicating highest floor served by standpipe (updated as necessary)
- **Site Safety Plan illustrating the following:**
- Labeled as “Site Safety Plan”
  - Full Size
  - The Site Safety plan must clearly identify “You Are Here” and illustrate the following:
    - a. Locations of standpipe(s), gas storage, fuel storage, hoists
    - b. Crane locations
    - c. Evacuation procedure
    - d. Muster points
    - e. Location of OS & Y valve
- **Access keys for any lock (storage cabinets, OS&Y valve, etc.) used within the construction site.**

**Appendix A. FDNY District Office Contact Information**

# FDNY District Offices

DO **1** , **3** , **11** & **15** (Fax #: 718-999-0096)

DO <b>1</b> Tel #: 718-999-0634 718-999-2929 718-999-2428 718-999-2073	DO <b>3</b> Tel #: 718-999-1052 718-999-2919 718-999-2842 718-999-1434 718-999-2667	DO <b>11</b> Tel #: 718-999-1641 718-999-2451 718-999-2452	DO <b>15</b> Tel #: 718-999-2453 718-999-2454 718-999-2455
--	--	---	---

DO <b>8</b> Fax #: 718-987-4186 Tel #: 718-987-3910 718-494-4560 718-494-2492	DO <b>12</b> Fax #: 718-331-4350 Tel #: 718-331-9400 718-331-9337 71/-331-9323	DO <b>13</b> Fax #: 718-441-3718 Tel #: 718-476-6271 718-476-6281 718-441-3717
---	--	--

DO **6** & **7** (Fax #: 718-583-4765)

DO <b>6</b> Text #: 718-583-7964 718-430-0231 718-430-0254	DO <b>7</b> Tel #: 718-583-9114 718-430-0257 718-430-0267
---	--

DO **14**  
Fax #: 718-352-8840  
Tel #: 718-352-8092  
718-352-8160  
718-352-8279  
718-352-8308  
718-352-8829

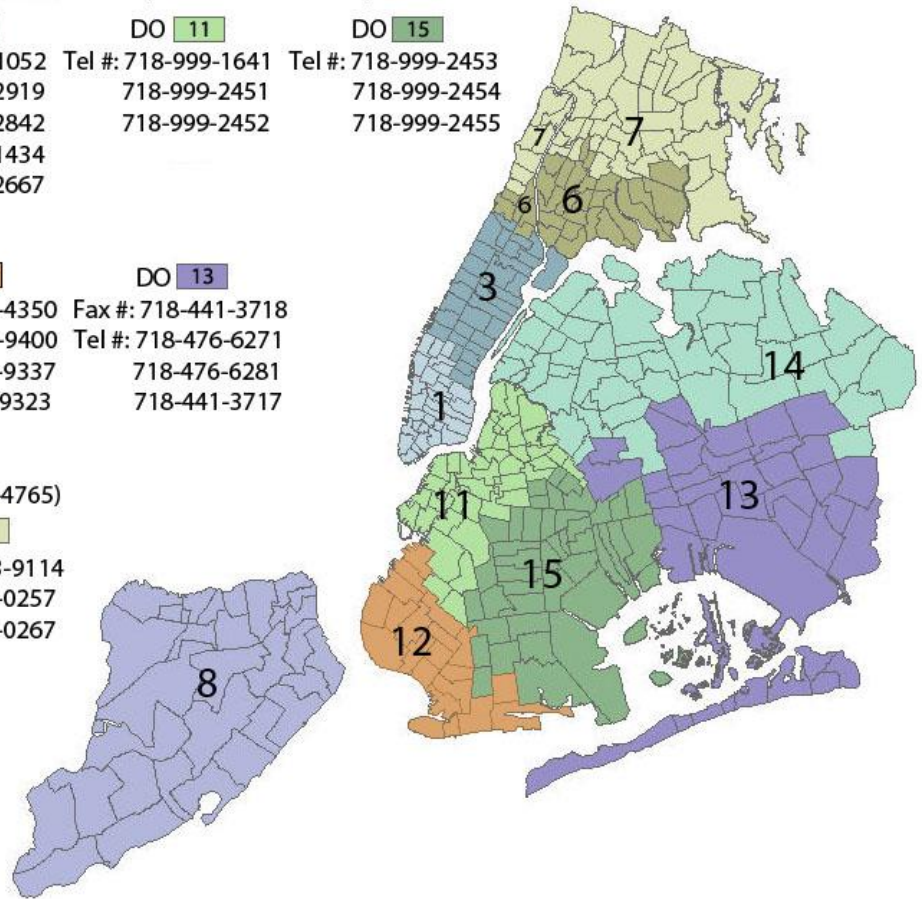

## **Appendix B. FIRE CODE**

**1406.2 Oxygen.** The storage, handling and use of oxygen shall comply with the requirements of FC 1406.2.1 through 1406.2.3, and FC Chapters 26 and 30, as applicable.

**1406.2.1 Portable liquid oxygen containers.** The storage, handling and use of portable liquid oxygen containers shall be in accordance with FC 1406.2.1.1 through 1406.2.1.9.

**1406.2.1.1 Design and installation documents.** A sketch showing the following information shall be submitted to the department for approval in connection with an application for a permit for oxygen storage:

1. Number and size of containers.
2. Enclosure, manifold and service piping construction.
3. Location of risers and outlets.
4. Location of all equipment and devices including vaporizers, valves and safety relief devices.

**1406.2.1.2 Indoor storage restrictions.** Not more than one liquid oxygen container having a maximum water capacity of 6.2 cubic feet (0.176 m<sup>3</sup>) may be stored indoors. Such container shall be connected for use with a flammable gas. Storage in excess of one liquid oxygen container shall be located outdoors.

**1406.2.1.3 Ventilation.** The room used for the storage, handling and use of a liquid oxygen container shall be equipped with ventilation direct to the outdoors, and shall not contain any combustible material or flammable gas.

**1406.2.1.4 Manifolds and vaporizers.** Manifolds and vaporizers shall be constructed of materials suitable for oxygen service at a pressure of 250 psig (1724 kPa). Such manifolds and vaporizers shall have a minimum bursting pressure of 1,000 psig (6895 kPa) and shall be protected with safety relief devices which will relieve at or below 500 psig (3448 kPa).

**1406.2.1.4.1 Test.** The assembled vaporizer and manifold shall be pressure tested at 500 psig (3448 kPa) with an oil-free and nonflammable material as the testing medium.

**1406.2.1.5 Service piping from the oxygen manifold.** Service piping from the oxygen manifold shall be copper tubing, stainless steel, wrought iron or steel, and shall run vertically outdoors to the floor or floors being serviced, where outlets may be provided for hose connections to approved torches. The service piping shall be properly secured, protected from damage from mechanical injury and properly labeled. Any connection between service piping and the manifold shall be made using not more than 5 feet (1524 mm) of hose capable of withstanding pressure up to at least 1,000 psig (6895 kPa).

**1406.2.1.5.1 Service pressure.** Service piping shall be suitable for 250 psig (1724 kPa) service unless an intervening pressure regulator is provided at the manifold, and shall withstand a test of two times the maximum operating pressure, using an oil-free and nonflammable material as the testing medium.

**1406.2.1.6 Hose and connectors.** Hose and connectors capable of withstanding pressure up to at least 1,000 psig (6895 kPa) and of a design suitable for oxygen service at a pressure of 250 psig (1724 kPa) shall be used to connect the outlets on the service piping to the blowpipes. Hose shall be rejected for use if it shows



excessive wear, loose connections, leaks or burns; hose subjected to a flash back in use shall be tested to twice the service pressure, but not less than 200 psig (1379 kPa), before being returned to service.

**1406.2.1.7 Signs.** Signs shall be posted in the vicinity of liquid oxygen container storage and use, reading: DANGER-LIQUID OXYGEN-NO SMOKING-NO OPEN FLAMES.

**1406.2.1.8 Operating instructions.** Legible operating instructions shall be posted near any liquid oxygen manifold.

**1406.2.1.9 Affidavit.** An affidavit shall be provided by the installer and/or contractor to certify that the vaporizer, valves, piping, hose and safety devices are of an approved type, that they meet the specifications for bursting test and design pressure, and that they have been satisfactorily tested in accordance with this section.

**1406.2.2 Oxygen trailers.** The storage and use of oxygen trailers shall be in accordance with FC 1406.2.2.1 through 1406.2.2.5.

**1406.2.2.1 Design, construction, testing and maintenance.** Oxygen trailer containers shall be designed, constructed, tested and maintained in accordance with the United States Department of Transportation specifications and regulations.

**1406.2.2.2 Instructions.** Legible operating instructions shall be posted in the trailer and on or near any oxygen manifold used indoors.

**1406.2.2.3 License plates.** Oxygen trailers shall at all times have affixed to them a motor vehicle license plate as issued in accordance with New York State or other applicable motor vehicle license plate laws, rules or regulations.

**1406.2.2.4 Notification.** The owner or operator of an oxygen trailer shall notify the department, in writing, of the delivery of the trailer to a construction site, at least 48 hours in advance of such delivery. Such notification shall include:

1. Contractor's name, address and telephone number.
2. Location of the construction site.
3. Quantity and frequency of oxygen delivery to the construction site.
4. Expected duration of oxygen storage and use at the construction site.

**1406.2.2.5 Oxygen trailers having a capacity exceeding 20,000 SCF (566 m<sup>3</sup>).** The distance between oxygen trailers having a total aggregate capacity exceeding 20,000 SCF (566 m<sup>3</sup>) and exposures shall be in accordance with NFPA 55.

**1406.2.3 Supervision.** The handling and use of portable liquid oxygen containers and oxygen trailers shall be under the personal supervision of a certificate of fitness holder. The storage of liquid oxygen containers and oxygen trailers shall be under the general supervision of a certificate of fitness holder.